



Gas Connectors & Accessories

2019 Wholesale Distribution Catalog

Superior Quality



Superior Service



Superior Selection

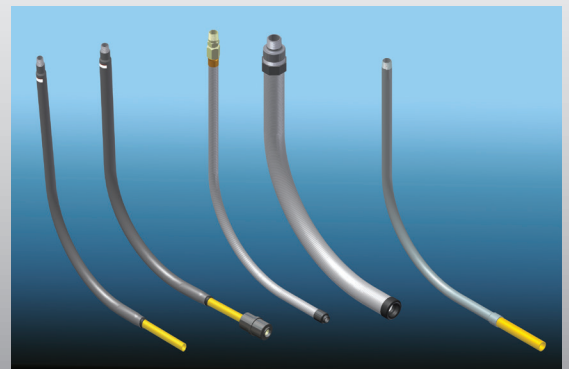

Effective Date 11/19

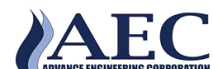

www.hubbell.com



For over 125 years Hubbell has been a manufacturer and innovator of best-in-class electrical and electronic products serving the residential, non-residential, construction , industrial and utility markets. The Hubbell Gas Connectors & Accessories group (HGCA) now brings that same business expertise and spirit of innovation to the natural gas market.

- Gas Distribution (LDC)
- Wholesale Plumbing & LP

Be sure to visit hubbell.com where you can find out more about Hubbell Gas Connectors & Accessories as well as visit each individual company website.

www.conind.com

www.gasbreaker.com

www.rwlyall.com

www.advengcorp.com

2019 Wholesale Distribution Catalog

Pricing Effective 06/01/2019

Table Of Contents

Con-Stab ID Seal® Fittings	
Con-Stab ID Seal® Full Couplings	4
Con-Stab ID Seal® End Caps	4
Con-Stab ID Seal® Cap-N-Go Couplings.....	4
Con-Stab ID Seal® 3-Way Tees	5
Con-Stab ID Seal® 90° Elbows	5
Con-Stab ID Seal® PE x Copper Transition Coupling.....	5
Con-Stab ID Seal® Reducer Couplings	6
Con-Stab ID Seal® Reducing 3-Way Tees.....	7
Con-Stab ID Seal® Eliminator Saddles.....	15
Con-Stab ID Seal® HVT Eliminator Saddles	16
Con-Stab ID Seal® Transition Fittings	20-21
LycoFit® Mechanical Fittings	
LycoFit® Mechanical Couplings.....	8
LycoFit® Mechanical End Caps.....	8
LycoFit® Mechanical 3-Way Tees	8
LycoFit® 90° Elbows	9
LycoFit® Reducer Couplings	9
LycoFit® Steel to PE Transition Fittings	9
LycoFit® PE. x Copper Tubing Adapter.....	10
Compression Fittings	
Lyll Mechanical Compression Couplings.....	12
Lyll Mechanical Compression Tees	12
Lyll Mechanical Compression Male Adapters	12
Continental Industries PA Full Couplings	13
Continental Industries PA End Caps	13
Continental Industries PA 3-Way Tees.....	13
Continental Industries PA 90° Elbows	14
Continental Industries PA Reducer Couplings.....	14
Continental Industries Eliminator Saddles.....	17
Continental Industries HVT (High Volume Tee) Saddles	18
Transition Fittings	
Lyll Threaded Transition Fittings.....	19
Con-Stab ID Seal® Transition Fittings	20-21
Meter Risers	
Lyll Anodeless Meter Risers	23
Continental Industries Anodeless Meter Risers.....	24
Lyll Flexible Service Head Adapter Risers.....	25
Continental Industries Conflex Risers	26
Lyll Compression (ANODE) Risers.....	27
Lyll Transition (ANODE) Risers	28
Riser Brackets	29-30
PolyTec Ball Valves	
PolyTec Medium Density PE Valve.....	31
PolyTec High Density PE Valve	32
Tools & Accessories	
LycoFit® Assembly Tools.....	10
Con-Stab® Chamfer Tools	11
Accessories for Eliminator Saddles.....	11
Tracer Wire	33



Gas Connectors & Accessories

CON STAB ID SEAL® FITTINGS

CON STAB ID SEAL® FULL COUPLINGS



CON-STAB ID SEAL® Full Couplings			
PE SIZE	WALL	PART NUMBER (3408/4710)	LIST PRICE
1/2" CTS (5/8" OD)	.090	3259-52-1004-00	\$16.98
3/4" CTS (7/8" OD)	.090	3259-52-1006-00	\$89.55
1" CTS (1 1/8" OD)	.099/.101	3259-52-1008-00	\$31.85
	.090	3259-52-1008-AA	\$31.85
1 1/4" CTS (1 3/8" OD)	.090	3259-52-1039-AA	\$68.13
1/2" IPS	SDR-9.33 (.090)	3259-52-1012-00	\$42.37
3/4" IPS	SDR-11 (.095)	3259-52-1013-00	\$29.43
1" IPS	SDR-11 (.119)	3259-52-1014-00	\$43.69
1 1/4" IPS	SDR-10 (.166)	3259-52-1015-00	\$96.20
	SDR-11 (.151)	3259-52-1015-AA	\$103.98
1 1/2" IPS	SDR-11 (.173)	3259-52-1016-00	\$110.99
2" IPS	SDR-11 (.216)	3259-52-1017-00	\$127.48

• For sizes not listed, contact Continental Industries.

CON STAB ID SEAL® END CAPS



CON-STAB ID SEAL® End Caps			
PE SIZE	WALL	PART NUMBER (3408/4710)	LIST PRICE
1/2" CTS (5/8" OD)	.090	3259-53-1004-00	\$16.98
3/4" CTS (7/8" OD)	.090	3259-53-1006-00	\$55.16
1" CTS (1 1/8" OD)	.099/.101	3259-53-1008-00	\$25.64
	.090	3259-53-1008-0A	\$25.64
1 1/4" CTS (1 3/8" OD)	.090	3259-53-1039-0A	\$59.37
1/2" IPS	SDR-9.33 (.090)	3259-53-1012-00	\$31.42
3/4" IPS	SDR-11 (.095)	3259-53-1013-00	\$25.27
1" IPS	SDR-11 (.119)	3259-53-1014-00	\$29.85
1 1/4" IPS	SDR-10 (.166)	3259-53-1015-00	\$109.66
	SDR-11 (.151)	3259-53-1015-0A	\$117.50
1 1/2" IPS	SDR-11 (.173)	3259-53-1016-00	\$125.79
2" IPS	SDR-11 (.216)	3259-53-1017-00	\$141.69

• For sizes not listed, contact Continental Industries.

CON STAB ID SEAL® CAP-N-GO COUPLINGS



CON-STAB ID SEAL® Cap-N-Go Couplings			
PE SIZE	WALL	PART NUMBER (3408/4710)	LIST PRICE
1/2" CTS (5/8" OD)	.090	3259-57-1004-00	\$26.39
1" CTS (1 1/8" OD)	.099/.101	3259-57-1008-00	\$41.39
	.090	3259-57-1008-AA	\$41.39
1/2" IPS	SDR-9.33 (.090)	3259-57-1012-00	\$50.27
3/4" IPS	SDR-11 (.095)	3259-57-1013-00	\$64.20
1" IPS	SDR-11 (.119)	3259-57-1014-00	\$46.14
1 1/4" IPS	SDR-10 (.166)	3259-57-1015-00	\$139.59
	SDR-11 (.151)	3259-57-1015-AA	\$139.59
2" IPS	SDR-11 (.216)	3259-57-1017-00	\$277.37

• For sizes not listed, contact Continental Industries.

CON STAB ID SEAL® FITTINGS



Gas Connectors & Accessories

CON STAB ID SEAL® 3 WAY TEES

CON-STAB ID SEAL® 3-Way Tees			
PE SIZE	WALL	PART NUMBER (3408/4710)	LIST PRICE
1/2" CTS (5/8" OD)	.090	3259-50-1004-00	\$58.70
3/4" CTS (7/8" OD)	.090	3259-50-1006-00	\$212.76
1" CTS (1 1/8" OD)	.099/.101	3259-50-1008-00	\$75.48
	.090	3259-50-1008-AA	\$75.48
1 1/4" CTS (1 3/8" OD)	.090	3259-50-1039-AA	\$178.13
1/2" IPS	SDR-9.33 (.090)	3259-50-1012-00	\$81.18
3/4" IPS	SDR-11 (.095)	3259-50-1013-00	\$79.54
1" IPS	SDR-11 (.119)	3259-50-1014-00	\$76.47
1 1/4" IPS	SDR-10 (.166)	3369-50-1015-00*	\$178.32
	SDR-11 (.151)	3259-50-1015-AA	\$188.76
1 1/2" IPS	SDR-11 (.173)	3259-50-1016-00	\$288.08

- For sizes not listed, contact Continental Industries.
- * = 1 1/4" IPS SDR-10 Fitting is only available in PE 2406 yellow.



CON STAB ID SEAL® 90° ELBOWS

CON-STAB ID SEAL® 90° Elbows			
PE SIZE	WALL	PART NUMBER (3408/4710)	LIST PRICE
1/2" CTS (5/8" OD)	.090	3259-51-1004-00	\$26.19
3/4" CTS (7/8" OD)	.090	3259-51-1006-00	\$40.74
1" CTS (1 1/8" OD)	.099/.101	3259-51-1008-00	\$40.43
	.090	3259-51-1008-AA	\$40.43
1 1/4" CTS (1 3/8" OD)	.090	3259-51-1039-AA	\$114.61
1/2" IPS	SDR-9.33 (.090)	3259-51-1012-00	\$55.73
3/4" IPS	SDR-11 (.095)	3259-51-1013-00	\$34.26
1" IPS	SDR-11 (.119)	3259-51-1014-00	\$39.17
1 1/4" IPS	SDR-10 (.166)	3259-51-1015-00	\$93.65
	SDR-11 (.151)	3259-51-1015-AA	\$137.43
1 1/2" IPS	SDR-11 (.173)	3259-51-1016-00	\$193.10
2" IPS	SDR-11 (.216)	3259-51-1017-00	\$167.17

- For sizes not listed, contact Continental Industries.



CON STAB ID SEAL® P.E. X COPPER TRANSITION COUPLING

CON-STAB ID SEAL® P.E. x Copper Transition Couplings				
PE SIZE	WALL	COPPER SIZE	PART NUMBER (3408/4710)	LIST PRICE
1/2" CTS (5/8" OD)	.090	1/4" OD	9943-99-0062-00	\$50.39
		3/8" OD	9943-99-0063-00	\$51.28
		1/2" OD	9943-99-0064-00	\$53.02
		5/8" OD	9943-99-0065-00	\$53.75
3/4" IPS	SDR-11 (.095)	5/8" OD	9943-99-0066-00	\$80.58

- For sizes not listed, contact Continental Industries.

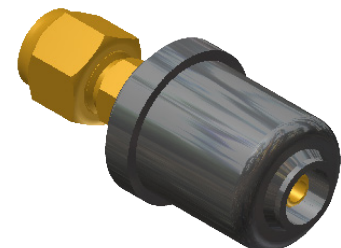



Gas Connectors & Accessories

CON STAB ID SEAL® FITTINGS

CON STAB ID SEAL® REDUCER COUPLING



CON-STAB ID SEAL® Reducer Couplings						
PE SIZE	WALL	PE SIZE	WALL	PART NUMBER (3408/4710)	LIST PRICE	
3/4" CTS (7/8" OD)	.090	1/2" CTS (5/8" OD)	.090	3259-54-0604-00	\$199.58	
1" CTS (1 1/8" OD)	.099/.101	3/4" IPS	SDR-11 (.095)	3259-54-0813-00	\$77.63	
	.090			3259-54-0813-A0	\$77.63	
	.099/.101	3/4" CTS (7/8" OD)	.090	3259-54-0806-00	\$80.54	
	.090			3259-54-0806-A0	\$80.54	
	.099/.101	1/2" IPS	SDR-9.33 (.090)	3259-54-0812-00	\$55.73	
	.090			3259-54-0812-A0	\$55.73	
	.099/.101	1/2" CTS (5/8" OD)	.090	3259-54-0804-00	\$73.67	
.090	3259-54-0804-A0			\$62.64		
1 1/4" CTS (1 3/8" OD)	.090	1" IPS	SDR-11	3259-54-3914-A0	\$103.06	
		1" CTS (1 1/8" OD)	.099/.101	3259-54-3908-A0	\$103.06	
			.090	3259-54-3908-AA	\$103.06	
1/2" IPS	SDR-9.33 (.090)	1/2" CTS (5/8" OD)	.090	3259-54-1204-00	\$92.64	
3/4" IPS	SDR-11 (.095)	1/2" IPS	SDR-9.33 (.090)	3259-54-1312-00	\$84.41	
		3/4" CTS (7/8" OD)	.090	3259-54-1306-00	\$75.74	
		1/2" CTS (5/8" OD)	.090	3259-54-1304-00	\$73.54	
1" IPS	SDR-11 (.119)	1" CTS (1 1/8" OD)	.099/.101	3259-54-1408-00	\$82.34	
			.090	3259-54-1408-OA	\$82.35	
		3/4" IPS	SDR-11 (.095)	3259-54-1413-00	\$82.11	
		3/4" CTS (7/8" OD)	.090	3259-54-1406-00	\$100.41	
		1/2" IPS	SDR-9.33 (.090)	3259-54-1412-00	\$89.54	
1 1/4" IPS	SDR-10 (.166) SDR-11 (.151)	1/2" CTS	.090	3259-54-1404-00	\$82.12	
		1 1/4" IPS	SDR-11 (.151)	3259-54-1515-OA	\$104.06	
			.090	3259-54-1539-AA	\$141.10	
		1" IPS	SDR-11 (.119)	3259-54-1514-00	\$140.66	
				3259-54-1514-A0	\$140.66	
		1" CTS (1 1/8" OD)	SDR-10 (.166) SDR-11 (.151)	.099/.101	3259-54-1508-00	\$110.97
				.090	3259-54-1508-OA	\$110.97
				.099/.101	3259-54-1508-A0	\$110.97
.090	3259-54-1508-AA			\$110.97		
3/4" IPS	SDR-11 (.095)	3259-54-1513-00	\$111.97			
		3259-54-1513-A0	\$111.97			
1 1/2" IPS	SDR-11 (.173)	3/4" IPS	SDR-11 (.095)	3259-54-1613-00	\$132.68	
		1" IPS	SDR-11 (.119)	3259-54-1614-00	\$136.75	
		1 1/4" IPS	SDR-10 (.166)	3369-54-1615-00	\$171.65	
SDR-11 (.151)	3259-54-1615-OA		\$171.65			
2" IPS	SDR-11	1 1/2" IPS	SDR-11 (.173)	3259-54-1716-00	\$179.96	
		1 1/4" IPS	SDR-10 (.166)	3369-54-1715-00	\$143.99	
			SDR-11 (.151)	3259-54-1715-OA	\$147.82	
		1" IPS	SDR-11 (.119)	3259-54-1714-00	\$143.24	
1" CTS (1 1/8" OD)	.099/.101	3259-54-1708-00	\$138.34			
		.090	3259-54-1708-OA	\$138.35		

• For sizes not listed, contact Continental Industries.

CON STAB ID SEAL® FITTINGS



Gas Connectors & Accessories

CON STAB ID SEAL® 3 WAY REDUCING TEES

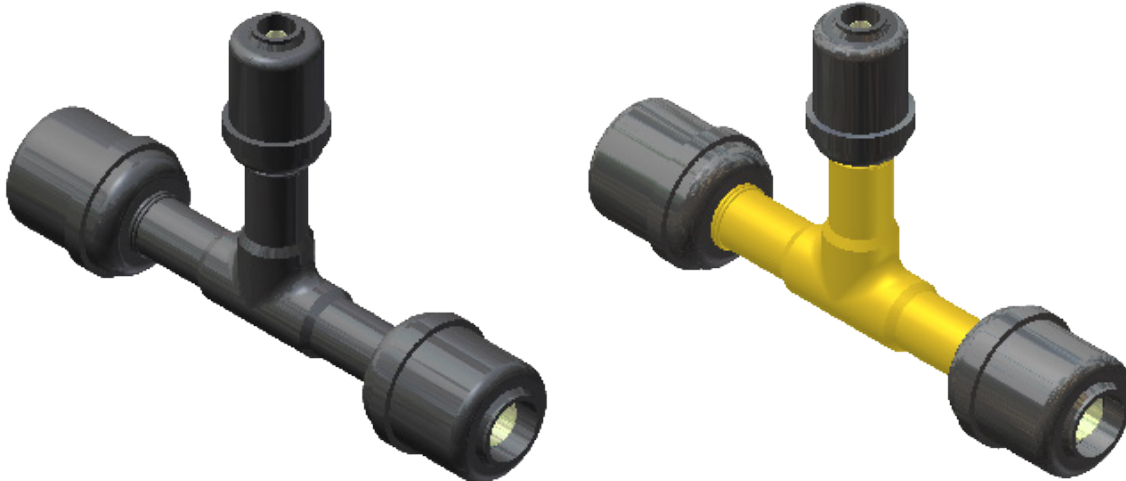

CON-STAB ID SEAL® 3-Way Reducing Tees								
PE SIZE (Run)	WALL	PE SIZE (Branch)	WALL	PART NUMBER (3408/4710) HDPE	LIST PRICE	PART NUMBER (2406) MDPE	LIST PRICE	
1/2" CTS (5/8" OD)	.090	1" CTS (1 1/8" OD)	.099/.101	3259-49-0408-00	\$144.04	3369-49-0408-00	\$144.04	
		1" CTS (1 1/8" OD)	.090	3259-49-0408-0A	\$144.04	3369-49-0408-0A	\$144.04	
3/4" CTS (7/8" OD)	.090	1/2" CTS (5/8" OD)	.090	3259-49-0604-00	\$193.68	3369-49-0604-00	\$193.68	
1" CTS (1 1/8" OD)	.099/.101	1/2" CTS (5/8" OD)	.090	3259-49-0804-00	\$113.80	3369-49-0804-00	\$113.80	
	.090			3259-49-0804-A0	\$113.80	3369-49-0804-A0	\$113.80	
1 1/4" CTS (1 3/8" OD)	.090	1/2" CTS (5/8" OD)	.090	3259-49-3904-A0	\$142.96	3369-49-3904-A0	\$142.96	
1/2" IPS	SDR-9.33 (.090)	1/2" CTS (5/8" OD)	.090	3259-49-1204-00	\$184.55	3369-49-1204-00	\$184.55	
3/4" IPS	SDR-11 (.095)	1/2" CTS (5/8" OD)	.090	3259-49-1304-00	\$123.68	3369-49-1304-00	\$123.38	
1" IPS	SDR-11 (.119)	1" CTS (1 1/8" OD)	.099/.101	3259-49-1408-00	\$239.40	3369-49-1408-00	\$239.40	
			.090	3259-49-1408-0A	\$239.40	3369-49-1408-0A	\$239.40	
		3/4" IPS	SDR-11 (.095)	3259-49-1413-00	\$260.74	3369-49-1413-00	\$260.74	
		1/2" CTS	.090	3259-49-1404-00	\$258.91	3369-49-1404-00	\$258.91	
1 1/4" IPS	SDR-10 (.166)	1" CTS (1 1/8" OD)	.099/.101	Not Available		3369-49-1508-00	\$228.21	
			.090	Not Available		3369-49-1508-0A	\$228.21	
	SDR-11 (.151)	1" CTS (1 1/8" OD)	.099/.101	3259-49-1508-A0	\$213.72	Not Available		
			.090	3259-49-1508-AA	\$213.72	Not Available		
	SDR-10 (.166)	1" IPS	SDR-11 (.119)	3259-49-1514-00	\$230.44	3369-49-1514-00	\$230.44	
				3259-49-1514-A0	\$236.62	3369-49-1514-A0	\$236.62	
	SDR-10 (.166)	SDR-11 (.151)	3/4" IPS	SDR-11 (.095)	Not Available		3369-49-1513-00	\$229.14
					3259-49-1513-A0	\$214.55	Not Available	
1 1/2" IPS	SDR-11 (.173)	1 1/4" IPS	SDR-10 (.166)	3259-49-1615-00	\$242.25	3369-49-1615-00	\$242.25	
			SDR-11 (.151)	3259-49-1615-0A	\$245.18	3369-49-1615-0A	\$245.18	
		1" IPS	SDR-11 (.119)	3259-49-1614-00	\$241.06	3369-49-1614-00	\$366.59	
		3/4" IPS	SDR-11 (.095)	3259-49-1613-00	\$236.96	3369-49-1613-00	\$236.96	
2" IPS	SDR-11	1 1/2" IPS	SDR-11 (.173)	3259-49-1716-00	\$257.59	3369-49-1716-00	\$257.59	
		1 1/4" IPS	SDR-10 (.166)	Not Available		3369-49-1715-00	\$478.04	
			SDR-11 (.151)	3259-49-1715-0A	\$407.42	3369-49-1715-0A	\$407.42	
		1" IPS	SDR-11 (.119)	3259-49-1714-00	\$277.61	3369-49-1714-00	\$277.61	
		3/4" IPS	SDR-11 (.095)	3259-49-1713-00	\$270.51	3369-49-1713-00	\$270.51	
1" CTS (1 1/8" OD)	.099/.101	1" CTS (1 1/8" OD)	.099/.101	3259-49-1708-00	\$439.96	3369-49-1708-00	\$454.13	
			.090	3259-49-1708-0A	\$373.08	3369-49-1708-0A	\$373.08	

• For sizes not listed, contact Continental Industries.

LYCOFIT[®] MECHANICAL FITTINGS



LYCOFIT[®] MECHANICAL COUPLINGS



LYCOFIT [®] MECHANICAL Couplings				
PE SIZE	WALL	MINIMUM QTY.	PART NUMBER	LIST PRICE
1/2" CTS	DR7	3	LC010B-DER	\$26.48
3/4" IPS	DR11	3	LC060Y-DER	\$48.41
1" IPS	DR11	3	LC070Y-DER	\$55.46
1 1/4" IPS	DR10/11	3	LC080X-DESR	\$118.41
1 1/2" IPS	DR11	2	LC090Y-DESR	\$146.66
2" IPS	DR11	2	LC200Y-DESR	\$192.39

LYCOFIT[®] MECHANICAL END CAPS

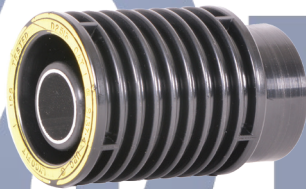

LYCOFIT [®] MECHANICAL End Caps				
PE SIZE	WALL	MINIMUM QTY.	PART NUMBER	LIST PRICE
3/4" IPS	DR11	3	LC060Y-ECR	\$46.57
1" IPS	DR11	3	LC070Y-ECR	\$50.69
1 1/4" IPS	DR10/11	3	LC080X-ECR	\$101.20
1 1/2" IPS	DR11	3	LC090Y-ECR	\$127.30
2 IPS	DR11	3	LC200Y-ECR	\$219.08

LYCOFIT[®] MECHANICAL 3-WAY TEES



LYCOFIT [®] MECHANICAL 3-Way Tees				
PE SIZE	WALL	MINIMUM QTY.	PART NUMBER	LIST PRICE
1/2" CTS	DR7	3	LC010B-3TR	\$117.16
3/4" IPS	DR11	3	LC060Y-3TR	\$125.76
1 IPS	DR11	3	LC070Y-3TR	\$145.01
1 1/4" IPS	DR10/11	3	LC080X-3TR	\$307.07
1 1/2" IPS	DR11	2	LC090Y-3TR	\$310.97
2" IPS	DR11	2	LC200Y-3TR	\$361.66

LYCOFIT[®] MECHANICAL FITTINGS



Gas Connectors & Accessories

90° ELBOWS

LYCOFIT [®] MECHANICAL 90° ELBOWS				
PE Pipe Size	Wall Thickness	Min. Qty	Product Code	List Price
½ CTS	DR7	3	LC010B-ELR	\$102.53
¾ IPS	DR11	3	LC060Y-ELR	\$104.22
1 IPS	DR11	3	LC070Y-ELR	\$108.15
1 ¼ IPS	DR10/11	3	LC080X-ELR	\$253.74
1 ½ IPS	DR11	2	LC090Y-ELR	\$282.50
2 IPS	DR11	2	LC200Y-ELR	\$325.89



REDUCER COUPLINGS

LYCOFIT [®] MECHANICAL REDUCER COUPLING				
Coupling Size	Wall Thickness	Min. Qty	Product Code	List Price
1 X ¾ IPS	DR11	3	LC070Y060Y-RR	\$163.56
1 ¼ X ¾ IPS	DR10/11	3	LC080X060Y-RR	\$167.55
1 ¼ X 1 IPS	DR10/11	3	LC080X070Y-RR	\$167.55
1 ½ X 1 ¼ IPS	DR11	3	LC090Y080X-RR	\$273.06
1 ½ X ¾ IPS	DR11	3	LC090Y060Y-RR	\$273.06
1 ½ X 1 IPS	DR11	3	LC090Y070Y-RR	\$273.06
2 X ¾ IPS	DR11	3	LC200Y060Y-RR	\$302.94
2 X 1 IPS	DR11	3	LC200Y070Y-RR	\$302.94
2 X 1 ¼ IPS	DR11	3	LC200Y080X-RR	\$302.94
2 X 1 ½ IPS	DR11	3	LC200Y090Y-RR	\$302.94



Note: Listed above are standard sizes available from Lyall. We can manufacture couplings in almost any configuration. If you don't see what you need listed, please contact Lyall customer service or your authorized sales representative for technical support and pricing information.

STEEL TO PE TRANSITION FITTINGS

STEEL TO PE TRANSITION FITTINGS				
Steel Pipe Size	PE Pipe Size	Min. Qty	Product Code	List Price
½ NPT SCH40	1/2 CTS .090/DR7	3	LC050S010B-SPB	\$55.53
¾ NPT SCH40	3/4 IPS DR11	3	LC060S060Y-SPB	\$63.86
1 NPT SCH40	1 IPS DR11	3	LC070S070Y-SPB	\$94.54
1 ¼ NPT SCH40	1-1/4 IPS DR10/11	3	LC080S080X-SPB	\$165.40
1 ½ NPT SCH40	1-1/2 IPS DR11	3	LC090S090Y-SPB	\$158.71
2 NPT SCH40	2 IPS DR11	3	LC200S200Y-SPB	\$506.26





Gas Connectors & Accessories

LYCOFIT[®] MECHANICAL FITTINGS

LYCOFIT[®] P.E. X COPPER TUBING ADAPTER

LYCOFIT [®] P.E. x Copper Tubing Adapter (Grill Adapter)				
PE SIZE	WALL	COPPER SIZE	PART NUMBER (3408/4710)	LIST PRICE
1/2" CTS	.090	3/8" OD GGS	LC375010B-GCR	\$116.69
		1/2" OD	LC500010B-GCR	\$97.18



LYCOFIT[®] ASSEMBLY TOOLS

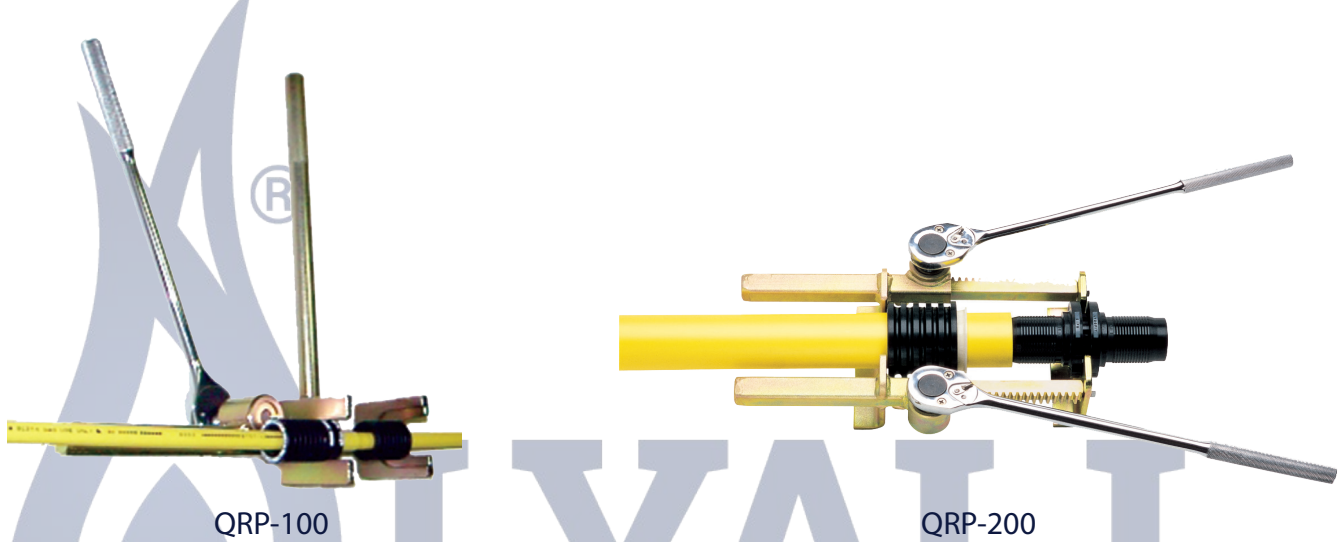

LYCOFIT [®] QUICK RATCHET PRESS (QRP) ASSEMBLY TOOL				
Tool	Fitting Sizes	Min. Qty	Product Code	List Price
QRP-100	1/2 CTS through 1 IPS	1	QRP-100	\$456.17
QRP-200	1/2 CTS through 2 IPS	1	QRP-200	\$1,212.44

Note:
 The QRP-100 tool requires one (1) long handled, 1/2" drive ratchet wrench to operate.
 The QRP-200 tool requires two (2) long handled, 1/2" drive ratchet wrenches to operate.

LYCOFIT [®] ASSEMBLY TOOL INSTALLATION CHART										
ToolModel	1/2 CTS	3/4 CTS	1 CTS	1-1/4 CTS	1/2 IPS	3/4 IPS	1 IPS	1-1/4 IPS	1-1/2 IPS	2 IPS
QRP-100	YES	YES	YES		YES	YES	YES			
QRP-200	YES*	YES*	YES*	YES*	YES*	YES*	YES*	YES*	YES*	YES*
LHP-200								YES	YES	YES

* Installs the coupling/fitting size indicated when using the appropriate adapter plates.

CON STAB ID SEAL® FITTINGS



Gas Connectors & Accessories

CHAMFER TOOL



DOUBLE ENDED ID CHAMFER TOOLS

PART NUMBER	DESCRIPTION	LIST PRICE
0000-33-5647-00	1/2" IPS X 1/2" CTS (5/8" OD)	\$43.38
0000-33-5481-00	3/4" IPS X 1/2" CTS (5/8" OD)	\$43.38
0000-33-5652-00	3/4" IPS X 1/2" IPS	\$43.38
0000-33-5651-00	3/4" CTS (7/8" OD) X 1/2" CTS (5/8" OD)	\$43.38
0000-33-5609-00	3/4" CTS (7/8" OD) X 1/2" IPS	\$43.38
0000-33-5480-00	1" CTS (1 1/8" OD) X 1/2" CTS (5/8" OD)	\$43.38
0000-33-5963-00	1" CTS (1 1/8" OD) X 1/2" IPS	\$43.38
0000-33-5763-00	1" CTS (1 1/8" OD) X 3/4" CTS (7/8" OD)	\$43.38
0000-33-5589-00	1" CTS (1 1/8" OD) X 3/4" IPS	\$43.38
0000-33-5514-00	1" IPS X 1/2" CTS (5/8" OD)	\$43.38
0000-33-5516-00	1" IPS X 3/4" IPS	\$43.38
0000-33-5606-00	1" IPS X 1" CTS (1 1/8" OD)	\$43.38
0000-33-5515-00	1 1/4" CTS (1 3/8" OD) X 1/2" CTS (5/8" OD)	\$43.38
0000-33-5798-00	1 1/4" CTS (1 3/8" OD) X 3/4" IPS	\$43.38
0000-33-5631-00	1 1/4" CTS (1 3/8" OD) X 1" CTS (1 1/8" OD)	\$43.38
0000-33-6572-00	1 1/4" CTS (1 3/8" OD) X 1" IPS	\$43.38

ID CHAMFER TOOLS WITH GAUGE

PART NUMBER	DESCRIPTION	LIST PRICE
0000-33-6580-04	1/2" CTS (5/8" OD) .090 WALL	\$43.38
0000-33-6580-06	3/4" CTS (7/8" OD) .090 WALL	\$43.38
0000-33-6580-02	1" CTS (1 1/8" OD) .090 WALL	\$43.38
0000-33-6580-08	1" CTS (1 1/8" OD) .099/.101 WALL	\$43.38
0000-33-6580-12	1/2" IPS SDR-9.3	\$43.38
0000-33-6580-13	3/4" IPS SDR-11	\$43.38
0000-33-6580-14	1" IPS SDR-11	\$43.38
0000-33-6580-03	1 1/4" CTS (1 3/8" OD) .090 WALL	\$43.38
0000-33-6580-10	1 1/4" IPS SDR-11 (.151 WALL)	\$43.38
0000-33-6580-15	1 1/4" IPS SDR-10 (.166 WALL)	\$43.38
0000-33-6580-09	1 1/4" IPS SDR-9.3 (.178 WALL)	\$43.38
0000-33-6580-16	1 1/2" IPS SDR-11	\$43.38
0000-33-6580-17	2" IPS SDR-11	\$43.38

ACCESSORIES FOR ELIMINATORS



33-5505-00 ~ Combination Tapping Tool & Saddle Bolt "T" Wrench for 1 1/4" thru 6" IPS Con-Stab ID Seal® Eliminators (List Price \$93.40)

33-5505-01 ~ Combination Tapping Tool & Saddle Bolt "T" Wrench for 3" thru 8" IPS Con-Stab ID Seal® Eliminators (List Price \$98.37)

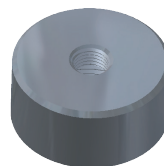

33-5508-00 ~ Test Plug Cap for Eliminator Saddles with 1/4" FPT for attachment of quick connect coupling (List Price \$94.83)

33-6290-00 ~ Test Plug Cap for HVT Saddles with 1/4" FPT for attachment of quick connect coupling (List Price \$177.21)

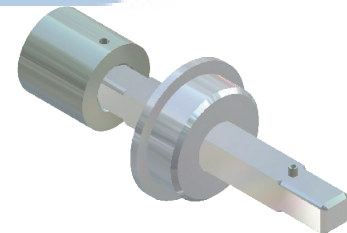

33-4363-00 ~ 1/2" Square Drive Key, Bushing & Socket Adapter Ass'y for HVT Eliminator Saddles (List Price \$253.66)



Gas Connectors & Accessories

MECHANICAL COMPRESSION FITTINGS

MECHANICAL COMPRESSION FITTINGS (EPOXY COATED)

Pressure rating: 10 psi

COMPRESSION COUPLINGS

COMPRESSION COUPLINGS					
PE SIZE	DR	Min. Order Qty	Product Code	NOTES	List Price
¾ IPS X ¾ IPS	11	5	361051050800	‡	\$82.88
1 IPS X 1 IPS	11	5	361321320800	‡	\$99.03
1 ¼ IPS X 1 ¼ IPS	10	3	361661660700	‡	\$108.40
1 ½ IPS X 1 ½ IPS	11	3	361901900800	‡	\$186.81
2 IPS X 2 IPS	11	3	362382380800	‡	\$263.57

‡ = IAPMO/UPC Listed
Includes built-in stiffener



COMPRESSION TEES

COMPRESSION TEES					
PE SIZE	DR	Min. Order Qty	Product Code	NOTES	List Price
¾ IPS X ¾ IPS	11	5	381051050800	‡	\$139.88
1 IPS X 1 IPS	11	5	381321320800	‡	\$168.87
1 ¼ IPS X 1 ¼ IPS	10	3	381661660700	‡	\$193.66

‡ = IAPMO/UPC Listed
Includes built-in stiffener



COMPRESSION MALE ADAPTERS

COMPRESSION MALE ADAPTERS					
Steel X PE	DR	Min. Order Qty	Product Code	NOTES	List Price
¾ NPT X ¾ IPS	11	5	341051050800	‡	\$47.65
1 NPT X 1 IPS	11	5	341321320800	‡	\$54.03
1 ¼ NPT X 1 ¼ IPS	10	3	341661660700	‡	\$66.88
1 ½ NPT X 1 ½ IPS	11	3	341901900800	‡	\$125.00
2 IPS X 2 IPS	11	3	342382380800	‡	\$145.48

‡ = IAPMO/UPC Listed
Includes built-in stiffener



COMPRESSION FITTINGS



PA COMPRESSION

PA COMPRESSION FULL COUPLINGS			
PE SIZE	WALL	PART NUMBER	LIST PRICE
1/2" CTS (5/8" OD)	.090	5657-52-1004-00	\$28.67
	.062	5657-52-1004-AA	\$28.67
1" CTS (1 1/8" OD)	.099/.101	5657-52-1008-00	\$43.56
	.090	5657-52-1008-AA	\$50.95
3/4" IPS	SDR-11 (.095)	5657-52-1013-00	\$43.56
1" IPS	SDR-11 (.119)	5657-52-1014-00	\$67.78
1 1/4" IPS	SDR-10 (.166)	5657-52-1015-00	\$144.77
	SDR-11 (.151)	5657-52-1015-AA	\$144.77
2" IPS	SDR-11 (.216)	5657-52-1017-00	\$201.42



• For sizes not listed, contact Continental Industries.

PA COMPRESSION END CAPS			
PE SIZE	WALL	PART NUMBER	LIST PRICE
1/2" CTS (5/8" OD)	.090	5657-53-1004-00	\$16.37
	.062	5657-53-1004-0A	\$16.37
1" CTS (1 1/8" OD)	.099/.101	5657-53-1008-00	\$27.18
	.090	5657-53-1008-0A	\$27.18
3/4" IPS	SDR-11 (.095)	5657-53-1013-00	\$27.20
1" IPS	SDR-11 (.119)	5657-53-1014-00	\$72.47
1 1/4" IPS	SDR-10 (.166)	5657-53-1015-00	\$114.23
	SDR-11 (.151)	5657-53-1015-0A	\$114.22
2" IPS	SDR-11 (.216)	5657-53-1017-00	\$122.66

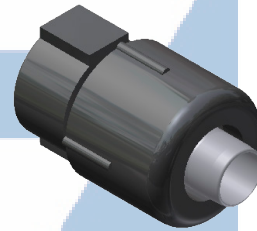

• For sizes not listed, contact Continental Industries.

PA COMPRESSION 3-WAY TEES			
PE SIZE	WALL	PART NUMBER	LIST PRICE
1/2" CTS (5/8" OD)	.090	5657-50-1004-00	\$50.31
	.062	5657-50-1004-AA	\$50.31
1" CTS (1 1/8" OD)	.099/.101	5657-50-1008-00	\$66.94
	.090	5657-50-1008-AA	\$66.94
3/4" IPS	SDR-11 (.095)	5657-50-1013-00	\$66.94



• For sizes not listed, contact Continental Industries.



Gas Connectors & Accessories

COMPRESSION FITTINGS

PA COMPRESSION

PA COMPRESSION 90° ELBOWS			
PE SIZE	WALL	PART NUMBER	LIST PRICE
1/2" CTS (5/8" OD)	.090	5657-51-1004-00	\$40.08
	.062	5657-51-1004-AA	\$40.08
1" CTS (1 1/8" OD)	.099/.101	5657-51-1008-00	\$53.06
	.090	5657-51-1008-AA	\$53.06
3/4" IPS	SDR-11 (.095)	5657-51-1013-00	\$66.94

• For sizes not listed, contact Continental Industries.



PA COMPRESSION REDUCER COUPLINGS						
PE SIZE	WALL	PE SIZE	WALL	PART NUMBER	LIST PRICE	
1/2" CTS (5/8" OD)	.090	1/2" CTS (5/8" OD)	.062	5657-54-0404-0A	\$28.67	
		1/4" CTS (3/8" OD)	.062	5657-54-0402-00	\$33.57	
	5657-54-0402-A0			\$33.57		
1" CTS (1 1/8" OD)	.099/.101	3/4" IPS	SDR-11 (.095)	5657-54-0813-00	\$55.85	
	.090			5657-54-0813-A0	\$55.85	
	.099/.101	1/2" CTS (5/8" OD)	.062	5657-54-0804-0A	\$36.35	
				5657-54-0804-AA	\$36.35	
	.099/.101			.090	5657-54-0804-00	\$36.35
					5657-54-0804-A0	\$36.35
3/4" IPS	SDR-11(.095)	1/2" CTS (5/8" OD)	.090	5657-54-1304-00	\$51.16	
			.062	5657-54-1304-0A	\$51.16	
1" IPS	SDR-11(.119)	1" CTS (1 1/8" OD)	.099/.101	5657-54-1408-00	\$69.22	
			.090	5657-54-1408-0A	\$69.22	
		3/4" IPS	SDR-11 (.095)	.090	5657-54-1413-00	\$69.22
				.062	5657-54-1404-00	\$56.58
		1/2" CTS		.062	5657-54-1404-0A	\$56.58
1 1/4" IPS	SDR-10(.166)	1 1/4" IPS	SDR-11 (.151)	5657-54-1015-0A	\$144.48	

• For sizes not listed, contact Continental Industries.



CON STAB ID SEAL® ELIMINATOR



Gas Connectors & Accessories

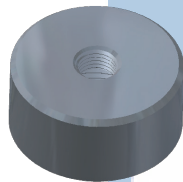

33-5508-00 ~ Test Plug Cap for Eliminator Saddles
page 11

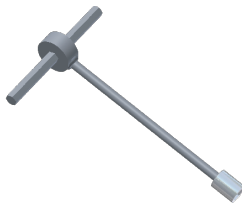

33-5505-00 ~ Combination Tapping Tool & Saddle Bolt "T"
Wrench for 1 1/4" thru 6" IPS Con-Stub ID
Seal® Eliminators page 11

33-5505-01 ~ Combination Tapping Tool & Saddle Bolt "T"
Wrench for 3" thru 8" IPS Con-Stub ID
Seal® Eliminators page 11

CON-STAB ID SEAL® ELIMINATORS						
OUTLET (PE SIZE)	WALL	MAIN SIZE	PART NUMBER 5864 1/2" CR PUNCH	LIST PRICE	PART NUMBER 5764 13/16" CR PUNCH	LIST PRICE
1/2" CTS (5/8" OD)	.090	1 1/4"	5864-15-1604-00	\$84.03	N/A	
		1 1/2"	5864-16-1604-00	\$136.75	N/A	
		2"	5864-17-1604-00	\$75.83	5764-17-1604-00†	\$84.51
		3"	5864-19-1604-00	\$90.29	5764-19-1604-00†	\$100.77
		4"	5864-21-1604-00	\$110.26	5764-21-1604-00†	\$111.61
		6"	5864-24-1604-00	\$113.99	5764-24-1604-00†	\$124.96
1" CTS (1 1/8" OD)	.099/.101	1 1/4"	5864-15-1608-00	\$91.60	N/A	
		2"	5864-17-1608-00	\$85.24	5764-17-1608-00	\$89.82
		3"	5864-19-1608-00	\$98.22	5764-19-1608-00	\$106.08
		4"	5864-21-1608-00	\$114.11	5764-21-1608-00	\$115.57
		6"	5864-24-1608-00	\$130.96	5764-24-1608-00	\$130.38
		8"	N/A		5764-26-1608-00	\$246.85
	.090	1 1/4"	5864-15-1608-0A	\$91.61	N/A	
		2"	5864-17-1608-0A	\$85.24	5764-17-1608-0A	\$106.07
		3"	5864-19-1608-0A	\$98.22	5764-19-1608-0A	\$115.57
		4"	5864-21-1608-0A	\$114.11	5764-21-1608-0A	\$130.38
		6"	5864-24-1608-0A	\$130.96	5764-24-1608-0A	\$130.38
		8"	N/A		5764-26-1608-0A	\$246.85
1/2" IPS	SDR-9.33 (.090)	1 1/4"	5864-15-1612-00	\$114.23	N/A	
		2"	5864-17-1612-00	\$106.54	5764-17-1612-00	\$112.21
		3"	5864-19-1612-00	\$122.56	5764-19-1612-00	\$133.42
		4"	5864-21-1612-00	\$142.54	5764-21-1612-00	\$144.34
		6"	5864-24-1612-00	\$163.48	5764-24-1612-00	\$162.76
		8"	N/A		5764-26-1612-00	\$274.34
3/4" IPS	SDR-11 (.095)	1 1/4"	5864-15-1613-00	\$91.61	N/A	
		1 1/2"	5864-16-1613-00	\$147.62	5764-16-1613-00	\$147.88
		2"	5864-17-1613-00	\$85.11	5764-17-1613-00†	\$89.70
		3"	5864-19-1613-00	\$98.10	5764-19-1613-00†	\$105.93
		4"	5864-21-1613-00	\$114.00	5764-21-1613-00†	\$115.46
		6"	5864-24-1613-00	\$130.74	5764-24-1613-00†	\$130.26
1" IPS	SDR-11 (.119)	1 1/4"	5864-15-1614-00	\$97.17	N/A	
		1 1/2"	5864-16-1614-00	\$153.27	5764-16-1614-00	\$153.27
		2"	5864-17-1614-00	\$90.77	5764-17-1614-00†	\$95.35
		3"	5864-19-1614-00	\$103.78	5764-19-1614-00†	\$111.46
		4"	5864-21-1614-00	\$119.65	5764-21-1614-00†	\$121.12
		6"	5864-24-1614-00	\$136.29	5764-24-1614-00†	\$135.80
8"	N/A		5764-26-1614-00	\$251.32		

CON STAB ID SEAL® HVT ELIMINATOR



CON-STAB ID SEAL® HVT ELIMINATORS				
OUTLET (PE SIZE)	WALL	MAIN SIZE	PART NUMBER	LIST PRICE
1 1/4" IPS	SDR-10 (.166)	2"	5664-17-1615-00	\$330.31
		3"	5664-19-1615-00	\$351.05
		4"	5664-21-1615-00	\$351.05
		6"	5664-24-1615-00	\$373.06
	SDR-11 (.151)	2"	5664-17-1615-0A	\$330.31
		3"	5664-19-1615-0A	\$351.05
		4"	5664-21-1615-0A	\$351.05
		6"	5664-24-1615-0A	\$373.06
2" IPS	SDR-11 (.216)	2"	5664-17-1617-00	\$336.97
		3"	5664-19-1617-00	\$359.34
		4"	5664-21-1617-00	\$359.34
		6"	5664-24-1617-00	\$382.23

• For sizes not listed, contact Continental Industries.

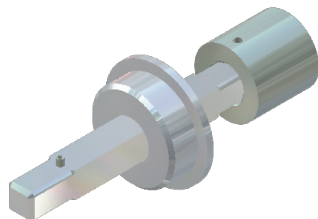

33-4363-00
1/2" Square Drive Key, Bushing and
Socket Adapter
page 11

PA COMPRESSION ELIMINATORS



Gas Connectors & Accessories

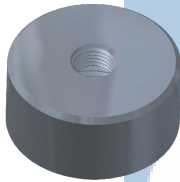

33-5508-00 ~ Test Plug Cap for Eliminator Saddles page 11

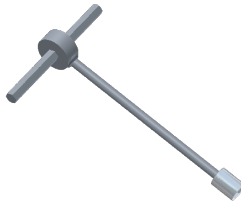

33-5505-00 ~ Combination Tapping Tool & Saddle Bolt "T" Wrench for 1 1/4" thru 6" IPS Con-Stab ID Seal® Eliminators page 11

33-5505-01 ~ Combination Tapping Tool & Saddle Bolt "T" Wrench for 3" thru 8" IPS Con-Stab ID Seal® Eliminators page 11

PA ELIMINATORS W/ COMPRESSION OUTLETS							
OUTLET (PE SIZE)	WALL	MAIN SIZE	PART NUMBER 5864 1/2" CR PUNCH	LIST PRICE	PART NUMBER 5764 13/16" CR PUNCH	LIST PRICE	
1/2" CTS (5/8" OD)	.090	1 1/4"	5864-15-1004-00	\$87.84	N/A		
		1 1/2"	5864-16-1004-00	\$158.53	N/A		
		2"	5864-17-1004-00	\$77.63	5764-17-1004-00	\$81.71	
		3"	5864-19-1004-00	\$95.59	5764-19-1004-00	\$99.86	
		4"	5864-21-1004-00	\$119.18	5764-21-1004-00	\$111.99	
		6"	5864-24-1004-00	\$123.96	5764-24-1004-00	\$126.99	
	.062	8"	N/A			5764-26-1004-00	\$214.81
		1 1/4"	5864-15-1004-0A	\$87.84	N/A		
		2"	5864-17-1004-0A	\$77.63	5764-17-1004-0A	\$81.71	
		3"	5864-19-1004-0A	\$95.90	5764-19-1004-0A	\$112.00	
		4"	5864-21-1004-0A	\$119.18	5764-21-1004-0A	\$111.99	
		6"	5864-24-1004-0A	\$123.97	5764-24-1004-0A	\$126.99	
1" CTS (1 1/8" OD)	.099/.101	8"	N/A		5764-26-1004-0A	\$214.81	
		1 1/4"	5864-15-1008-00	\$96.20	N/A		
		2"	5864-17-1008-00	\$85.72	5764-17-1008-00	\$86.28	
		3"	5864-19-1008-00	\$103.16	5764-19-1008-00	\$104.31	
		4"	5864-21-1008-00	\$122.42	5764-21-1008-00	\$115.00	
		6"	5864-24-1008-00	\$142.77	5764-24-1008-00	\$131.24	
	.090	8"	N/A			5764-26-1008-00	\$226.84
		1 1/4"	5864-15-1008-0A	\$94.97	N/A		
		2"	5864-17-1008-0A	\$85.72	5764-17-1008-0A	\$86.28	
		3"	5864-19-1008-0A	\$103.16	5764-19-1008-0A	\$104.31	
		4"	5864-21-1008-0A	\$122.42	5764-21-1008-0A	\$115.00	
		6"	5864-24-1008-0A	\$142.77	5764-24-1008-0A	\$131.24	
3/4" IPS	SDR-11 (.095)	8"	N/A		5764-26-1008-0A	\$226.84	
		1 1/4"	5864-15-1013-00	\$102.93	N/A		
1 1/2"		5864-16-1013-00	\$166.86	5764-16-1013-00	\$154.29		
2"		5864-17-1013-00	\$85.72	5764-17-1013-00	\$86.28		
3"		5864-19-1013-00	\$103.16	5764-19-1013-00	\$104.31		
4"		5864-21-1013-00	\$122.42	5764-21-1013-00	\$115.00		
1" IPS	SDR-11 (.119)	6"	5864-24-1013-00	\$142.77	5764-24-1013-00	\$131.24	
		8"	N/A		5764-26-1013-00	\$228.04	
		1 1/4"	5864-15-1014-00	\$113.76	N/A		
		1 1/2"	5864-16-1014-00	\$175.45	5764-16-1014-00	\$162.23	
		2"	5864-17-1014-00	\$104.11	5764-17-1014-00	\$106.19	
		3"	5864-19-1014-00	\$158.66	5764-19-1014-00	\$160.75	
1" IPS	SDR-11 (.119)	4"	5864-21-1014-00	\$145.54	5764-21-1014-00	\$144.14	
		6"	5864-24-1014-00	\$201.77	5764-24-1014-00	\$196.80	
		8"	N/A		5764-26-1014-00	\$232.38	

• For sizes not listed, contact Continental Industries.

PA HVT COMPRESSION ELIMINATORS



PA HVT ELIMINATORS W/ COMPRESSION OUTLETS				
OUTLET (PE SIZE)	WALL	MAIN SIZE	PART NUMBER 1 1/2" CR PUNCH	LIST PRICE
1 1/4" IPS	SDR-10 (.166)	2"	5664-17-1015-00	\$330.30
		3"	5664-19-1015-00	\$351.04
		4"	5664-21-1015-00	\$351.04
		6"	5664-24-1015-00	\$373.06
	SDR-11 (.151)	2"	5664-17-1015-0A	\$330.30
		3"	5664-19-1015-0A	\$351.04
		4"	5664-21-1015-0A	\$351.04
		6"	5664-24-1015-0A	\$373.06
2" IPS	SDR-11 (.216)	2"	5664-17-1017-00	\$336.97
		3"	5664-19-1017-00	\$359.34
		4"	5664-21-1017-00	\$359.34
		6"	5664-24-1017-00	\$382.21

• For sizes not listed, contact Continental Industries.

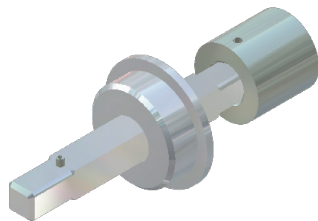

33-4363-00
1/2" Square Drive Key, Bushing and
Socket Adapter
page 11

TRANSITION FITTINGS



STEEL TO POLYETHYLENE (PE) TRANSITION FITTINGS

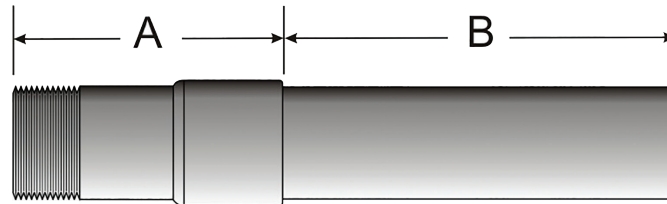

THREADED TRANSITION FITTINGS							
SIZE STEEL X PE	PE TYPE	STEEL LENGTH "A"	PE LENGTH "B"	MIN. ORDER QTY	THD TRAN PRODUCT CODE	NOTES	LIST PRICE
3/4 NPT X 3/4 IPS DR11	PE2406/PE2708	5"	12"	6	101051050800	††	\$37.47
1 NPT X 1 IPS DR11	PE2406/PE2708	5"	12"	3	101321320800	††	\$43.47
1 1/4 NPT X 1 1/4 IPS DR10	PE2406/PE2708	5 1/2"	12"	2	101661660700	††	\$55.37
1 1/2 NPT X 1 1/2 IPS DR11	PE2406/PE2708	5 1/2"	12"	2	101901900800	‡	\$63.30
2 NPT X 2 IPS DR11	PE2406/PE2708	5 3/4"	12"	2	102382380800	††	\$77.37

† = CSA Approved / ‡ = IAPMO/UPC Listed

Recommended accessories: socket fusion couplings, wire lugs, protector sleeves

Notes:

- A Fusion Bonded Epoxy (FBE) coating is applied to the external surface on all sizes up to 8 IPS
- An internal epoxy coating is available upon request on sizes under 4".

In addition to threaded transition fittings, Lyall offers several other types of transition connections. Please contact us for pricing and technical information on the following configurations:



Beveled for Welding



Victaulic Groove



Flanged



Gas Connectors & Accessories

TRANSITION FITTINGS

CON STAB ID SEAL® STEEL TRANSITION FITTINGS



CON-STAB ID SEAL® STEEL TRANSITION FITTINGS						
OUTLET (PE SIZE)	WALL	INLET	PART NUMBER 2406 MDPE	LIST PRICE	PART NUMBER 3408/4710 HDPE	LIST PRICE
1/2" CTS (5/8" OD)	.090	1/2" MPT	4646-00-1904-25	\$55.80	4949-00-1904-25	\$57.26
1" CTS (1 1/8" OD)	.099/.101	1" MPT	4646-00-1908-25	\$67.07	4949-00-1908-25	\$62.72
1/2" IPS	SDR-9.33 (.090)	3/4" MPT	4646-00-1912-25	\$184.14	4949-00-1912-25	\$53.55
3/4" IPS	SDR-11 (.095)	3/4" MPT	4646-00-1913-25	\$54.93	4949-00-1913-25	\$63.12
1" IPS	SDR-11 (.119)	1" MPT	4646-00-1914-25	\$75.35	4949-00-1914-25	\$76.84
1 1/4" IPS	SDR-10 (.166)	1 1/4" MPT	4646-00-1915-25	\$127.60	4949-00-1915-25	\$119.35
1 1/4" IPS	SDR-11 (.151)	1 1/4" MPT	9946-00-0058-25	\$172.90	9949-00-0001-25	\$168.25
1 1/2" IPS	SDR-11 (.171)	1 1/2" MPT	4646-00-1916-25	\$195.53	4949-00-1916-25	\$185.13
2" IPS	SDR-11 (.166)	2" MPT	4646-00-1917-25	\$175.96	4949-00-1917-25	\$170.85

• For sizes not listed, contact Continental Industries.

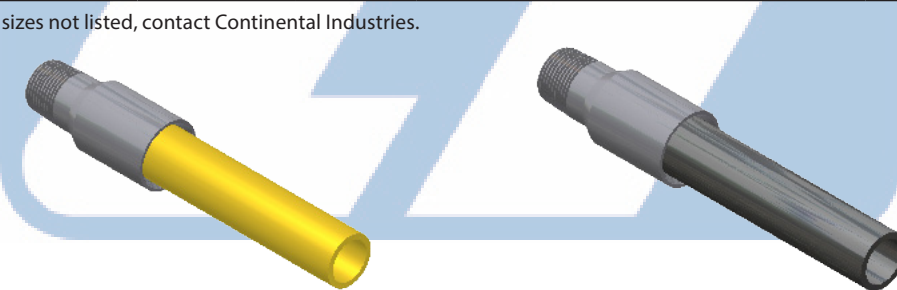

TRANSITION FITTINGS						
OUTLET (PE SIZE)	WALL	INLET	PART NUMBER 2406 MDPE	LIST PRICE	PART NUMBER 3408/4710 HDPE	LIST PRICE
1/2" CTS (5/8" OD)	.090	1/2" MPT	4646-00-1904-00	\$35.25	4949-00-1904-00	\$40.66
1" CTS (1 1/8" OD)	.099/.101	1" MPT	4646-00-1908-00	\$42.58	4949-00-1908-00	\$31.16
1/2" IPS	SDR-9.33 (.090)	3/4" MPT	4646-00-1912-00	\$74.87	4949-00-1912-00	\$54.23
3/4" IPS	SDR-11 (.095)	3/4" MPT	4646-00-1913-00	\$25.92	4949-00-1913-00	\$25.94
1" IPS	SDR-11 (.119)	1" MPT	4646-00-1914-00	\$31.83	4949-00-1914-00	\$33.74
1 1/4" IPS	SDR-10 (.166)	1 1/4" MPT	4646-00-1915-00	\$46.78	4949-00-1915-00	\$46.62
1 1/4" IPS	SDR-11 (.151)	1 1/4" MPT	4646-00-1915-0A	\$59.55	4949-00-1915-0A	\$55.49
1 1/2" IPS	SDR-11 (.171)	1 1/2" MPT	4646-00-1916-00	\$66.23	4949-00-1916-00	\$77.88
2" IPS	SDR-11 (.166)	2" MPT	4646-00-1917-00	\$69.67	4949-00-1917-00	\$73.93

• For sizes not listed, contact Continental Industries.

TRANSITION FITTINGS



Gas Connectors & Accessories

CON STAB ID SEAL® BRASS TRANSITION FITTINGS

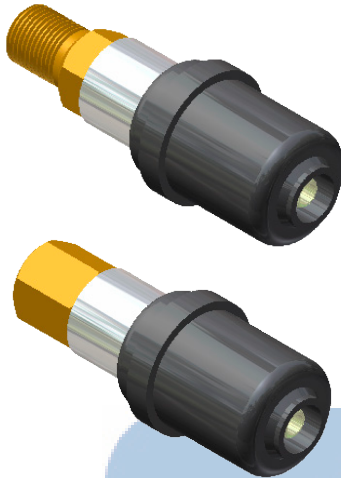

CON-STAB ID SEAL® BRASS TRANSITION FITTINGS				
OUTLET (PE SIZE)	WALL	INLET	PART NUMBER (3408/4710)	LIST PRICE
1/2" CTS (5/8" OD)	.090	1/2" MPT	9932-00-0002-00	\$80.84
		1/2" FPT	9932-00-0019-00	\$108.58
1" CTS (1 1/8" OD)	.099/.101	3/4" MPT	9932-00-0008-00	\$100.22
		3/4" FPT	9932-00-0025-00	\$103.04
	.090	3/4" MPT	9932-00-0007-00	\$100.22
		3/4" FPT	9932-00-0024-00	\$103.04
3/4" IPS	SDR-11 (.095)	3/4" MPT	9932-00-0015-00	\$94.34
		3/4" FPT	9932-00-0032-00	\$97.12

• For sizes not listed, contact Continental Industries.

STEEL TRANSITION FITTINGS

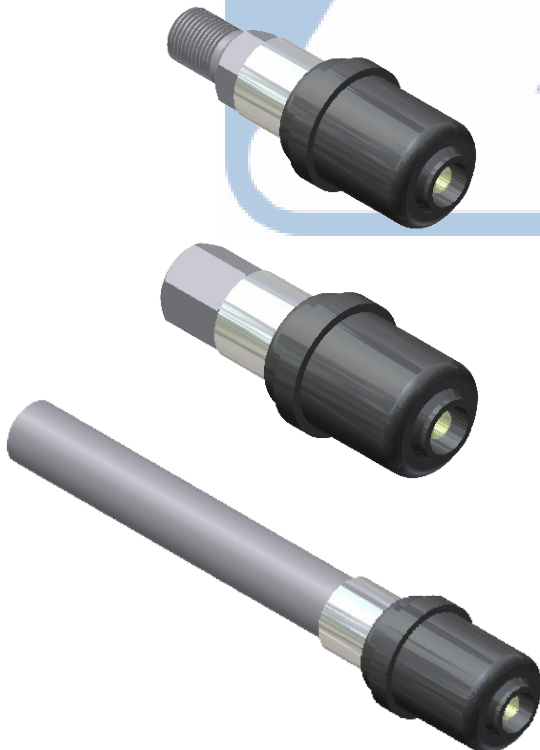

CON-STAB ID SEAL® STEEL TRANSITION FITTINGS				
OUTLET (PE SIZE)	WALL	INLET	PART NUMBER (3408/4710) HDPE	LIST PRICE
1/2" CTS (5/8" OD)	.090	1/2" MPT	0432-00-0912-00	\$84.82
		1/2" FPT	0432-00-1512-00	\$79.60
		3/4" MPT	0432-00-0913-00	\$84.72
		3/4" FPT	0432-00-1513-00	\$86.87
		3/4" BUTT WELD	0432-00-0613-00	\$86.16
1" CTS (1 1/8" OD)	.099/.101	3/4" MPT	0832-00-0913-00	\$89.81
		3/4" FPT	0832-00-1513-00	\$84.82
		1" MPT	0832-00-0914-00	\$93.17
		1" FPT	0832-00-1514-00	\$88.16
	.090	3/4" BUTT WELD	0832-00-0613-00	\$91.11
		3/4" MPT	0832-00-0913-A0	\$82.13
		3/4" FPT	0832-00-1513-A0	\$84.42
1/2" IPS	SDR-9.33 (.090)	1" MPT	0832-00-0914-A0	\$85.48
		1" FPT	0832-00-1514-A0	\$88.16
		3/4" BUTT WELD	0832-00-0613-A0	\$91.11
		1/2" MPT	1232-00-0912-00	\$109.83
		1/2" FPT	1232-00-1512-00	\$103.31
3/4" IPS	SDR-11 (.095)	3/4" MPT	1232-00-0913-00	\$100.76
		3/4" FPT	1232-00-1513-00	\$103.31
		3/4" MPT	1332-00-0913-00	\$118.81
		3/4" FPT	1332-00-1513-00	\$90.12
		1" MPT	1332-00-0914-00	\$120.83
1" FPT	1332-00-1514-00	\$93.90		
3/4" BUTT WELD	1332-00-0613-00	\$89.10		

• For sizes not listed, contact Continental Industries.



Gas Connectors & Accessories

SERVICE RISERS

ANODELESS SERVICE RISERS

The positive transition joint between the polyethylene (PE) pipe and the gas carrying steel pipe is made above ground and does not require cathodic (anode) protection.

RIGID ANODELESS RISERS

Pre-bent anodeless meter risers have a wide range of different designs and dimensions. While the most common connection is male pipe threads at the meter set connection, other styles such as flanges, beveled end for welding and bypass nipples are also available. For protection, these riser casings are coated with an electrostatically applied thin film epoxy coating. Standard configurations include various vertical and horizontal dimensions.

FLEXIBLE ANODELESS RISERS

Flexible anodeless service risers offer many of the features of the pre-bent design with an added feature utilizing gas tubing armour flexible metal hose. The flexible tubing is attached to the steel portion of the riser with a transition that is stronger in tensile than the flex tubing itself. Flexible Risers are ideal for variable ground level depths and eliminates the need for purchasing risers with various vertical lengths.

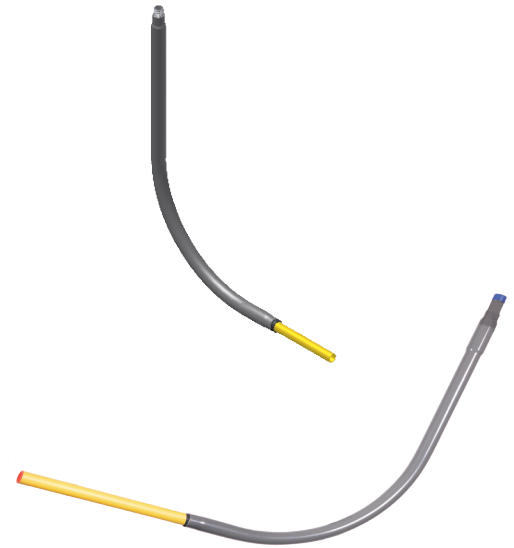

FLEXIBLE SERVICE HEAD ADAPTER RISERS

Flexible service head adapter risers offer many of the features that the pre-bent service head adapter riser offer, with an added feature utilizing gas tubing armour flexible hose. The flexible hose is attached to the steel portion of the riser with a transition that is stronger in tensile than the flex hose itself. Using flexible hose provides the user with a design that permits variable ground level depths and eliminates the need for purchasing risers with various vertical lengths.



TRANSITION (ANODE) SERVICE RISERS

The positive transition joint between the polyethylene (PE) pipe and gas carrying steel casing is made below ground. Field installation of an anode is recommended.

TRANSITION (ANODE) RISERS

Lyall Transition Risers are manufactured using schedule 40 steel pipe with a transition fitting as an integral part of riser. Each riser has an external thin film epoxy coating to protect against corrosion.



COMPRESSION (ANODE) RISERS

Lyall Compression Risers are manufactured using schedule 40 steel pipe welded to a compression fitting with a built in stiffener and gasket. Compression risers can be installed with conventional and tools eliminating the need for fusion equipment.



ANODELESS SERVICE RISERS



Gas Connectors & Accessories

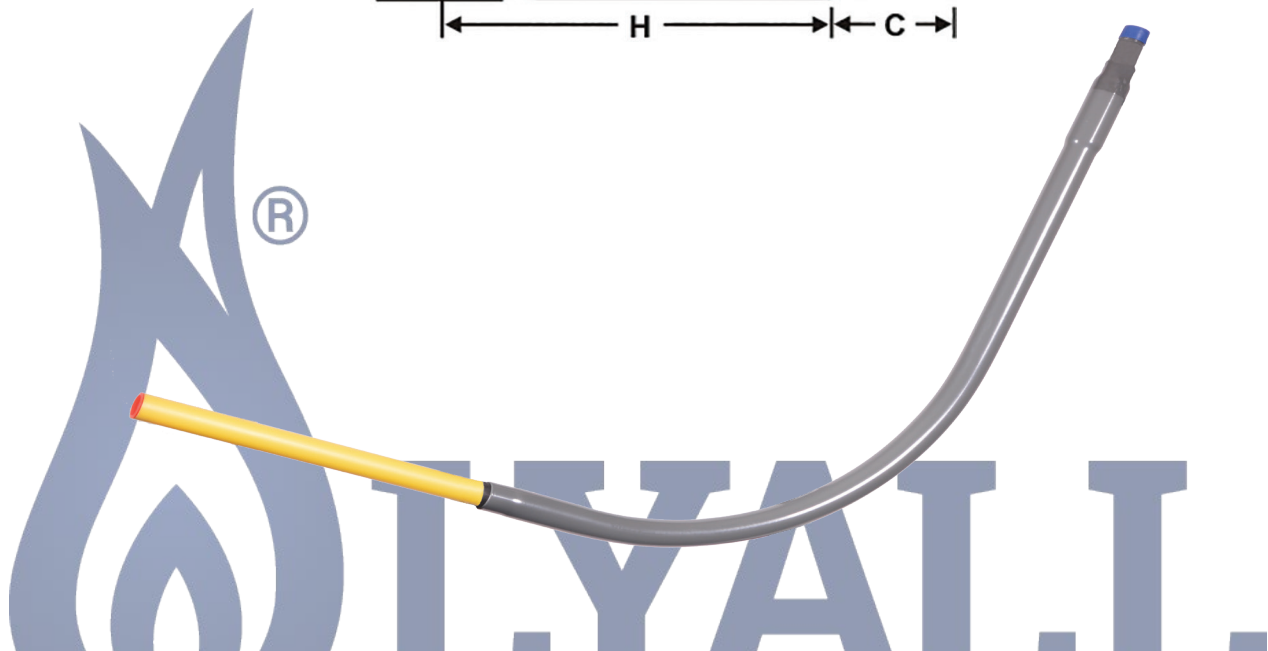
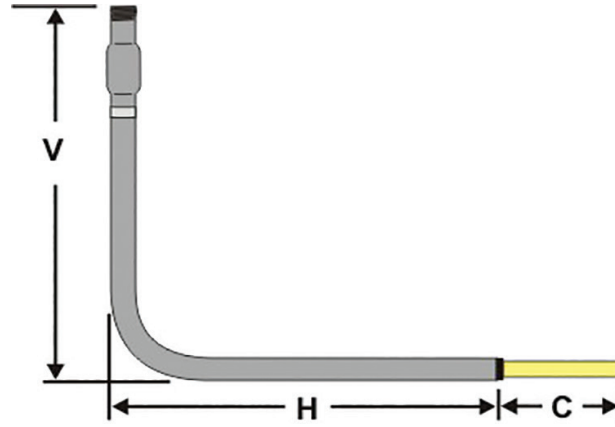

LYALL ANODELESS SERVICE RISER

SIZE STEEL X PE	PE TYPE	VERTICAL LENGTH "V"	HORIZONTAL LENGTH "H"	PE LENGTH "C"	BUNDLE/MIN. ORDER QTY.	PART NUMBER	NOTES	LIST PRICE
3/4 NPT X 1/2 CTS .090	PE2406/PE2708	30"	16"	10"	12	241050630130	†‡	\$55.84
3/4 NPT X 3/4 IPS DR11	PE2406/PE2708	30"	16"	10"	9	241051050830	†‡	\$67.50
1 NPT X 1 IPS DR11	PE2406/PE2708	30"	16"	10"	6	241321320830	†‡	\$78.13
1 1/4 NPT X 1 1/4 IPS DR10	PE2406/PE2708	30"	22"	10"	4	241661660760	†‡	\$127.64
1 1/2 NPT X 1 1/2 IPS DR11	PE2406/PE2708	30"	32"	10"	4	241901900830	‡	\$204.49
2 NPT X 2 IPS DR11	PE2406/PE2708	30"	30"	10"	2	242382380840	†‡	\$256.12

For sizes or PE Type not listed, please contact Lyall Customer Service.

† = CSA Approved / ‡ = IAPMO/UPC Listed

RISERS MUST BE ORDERED IN MULTIPLES OF BUNDLE QUANTITY LISTED



Gas Connectors & Accessories

ANODELESS SERVICE RISERS

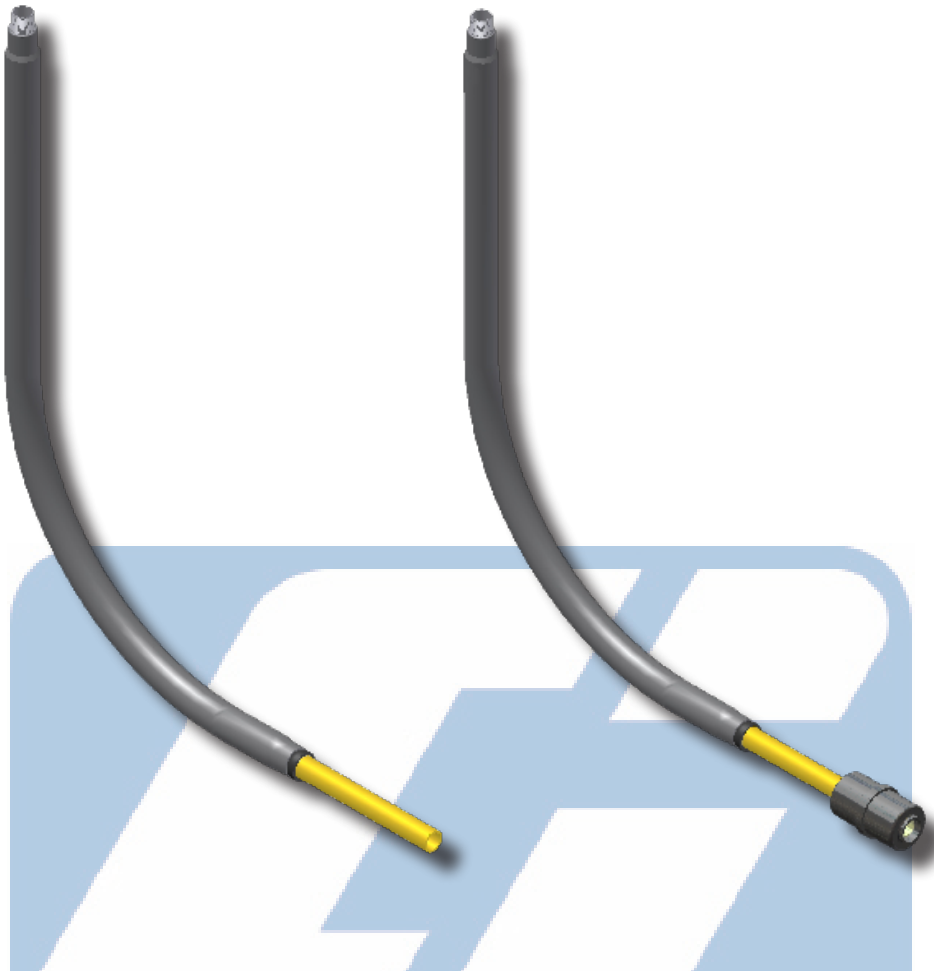

CONTINENTAL INDUSTRIES ANODELESS METER RISER

SIZE (MPT X PE)	WALL	VERTICAL LENGTH	HORIZONTAL LENGTH	PART NUMBER	LIST PRICE	PART NUMBER with Con-Stab	LIST PRICE
1/2" MPT X 1/2" CTS (5/8" OD) PE	0.090	30"	15"	1253-91-4604-00	\$61.86	1253-91-4604-25	\$81.07
3/4" MPT X 1/2" CTS (5/8" OD) PE	0.090	18"	19"	9953-99-0520-00	\$59.37	9953-99-0521-00	\$80.63
3/4" MPT X 1/2" CTS (5/8" OD) PE	0.090	30"	17"	1353-91-4604-00	\$60.38	1353-91-4604-25	\$65.91
3/4" MPT X 1/2" IPS PE	SDR-9.3 (.090)	30"	17"	1353-91-4612-00	\$61.89	1353-91-4612-25	\$85.59
3/4" MPT X 3/4" IPS PE	SDR-11 (.095)	30"	16"	1353-91-4613-00	\$66.16	1353-91-4613-25	\$106.13
3/4" MPT X 1" CTS (1 1/8" OD) PE	099/.101	30"	16"	1353-91-4608-00	\$73.09	1353-91-4608-25	\$108.18
1" MPT X 1" IPS PE	SDR-11 (.119)	30"	16"	1453-91-4614-00	\$75.90	1453-91-4614-25	\$119.10
1 1/4" MPT X 1 1/4" IPS PE	SDR-10 (.166)	30"	22"	1553-91-4615-00	\$130.36	1553-91-4615-25	\$264.03
1 1/4" MPT X 1 1/4" IPS PE	SDR-11 (.151)	30"	22"	1553-91-4615-0A	\$130.38	9953-99-0503-25	\$264.04
1 1/2" MPT X 1 1/2" IPS PE	SDR-11 (.173)	36"	26"	1652-91-4616-00	\$183.19	1652-91-4616-25	\$300.94
2" MPT X 2" IPS PE	SDR-11 (.216)	36"	30"	1752-91-4617-00	\$238.84	1752-91-4617-25	\$396.97

• For sizes not listed, contact Continental Industries.

FLEXIBLE SERVICE HEAD ADAPTER RISERS



Gas Connectors & Accessories

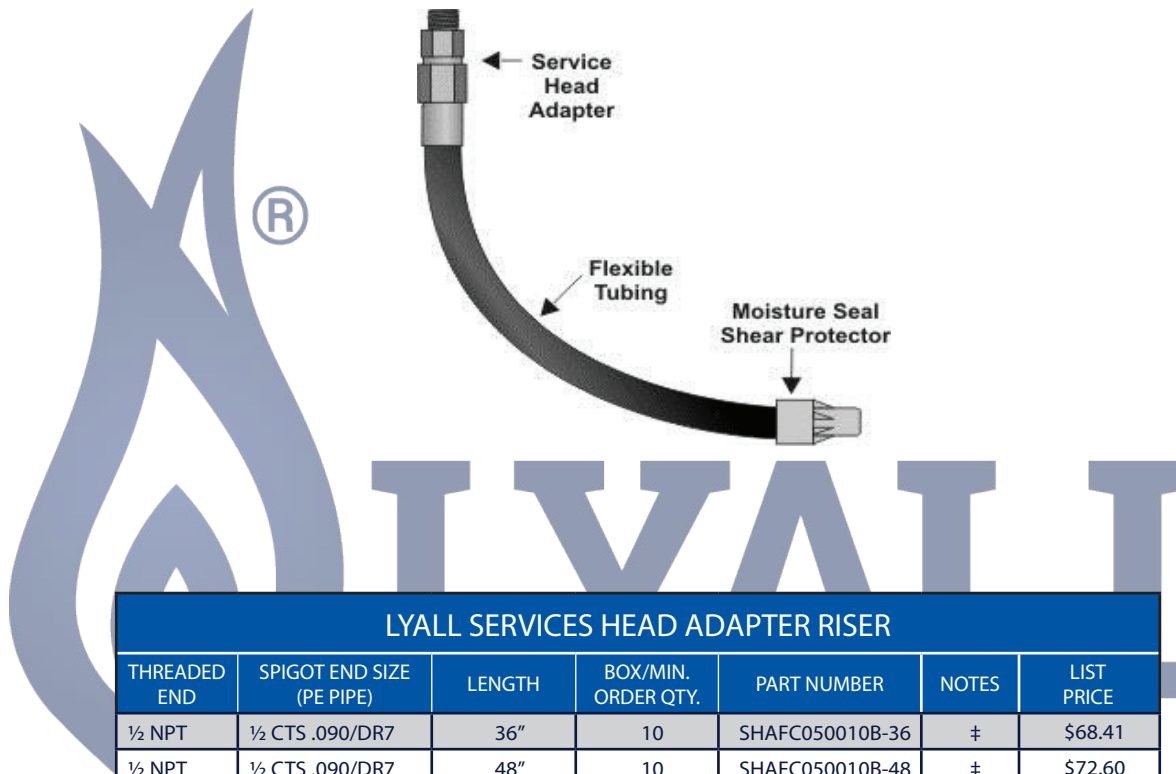

LYALL SERVICES HEAD ADAPTER RISER						
THREADED END	SPIGOT END SIZE (PE PIPE)	LENGTH	BOX/MIN. ORDER QTY.	PART NUMBER	NOTES	LIST PRICE
½ NPT	½ CTS .090/DR7	36"	10	SH AFC050010B-36	‡	\$68.41
½ NPT	½ CTS .090/DR7	48"	10	SH AFC050010B-48	‡	\$72.60
½ NPT	½ CTS .090/DR7	84"	10	SH AFC050010B-84	‡	\$77.82
½ NPT	½ IPS DR9.3	36"	10	SH AFC050050W-36	‡	\$119.84
½ NPT	½ IPS DR9.3	48"	10	SH AFC050050W-48	‡	\$128.26
½ NPT	½ IPS DR9.3	84"	10	SH AFC050050W-84	‡	\$136.70
¾ NPT	½ CTS .090/DR7	36"	10	SH AFC060010B-36	†‡	\$67.40
¾ NPT	½ CTS .090/DR7	48"	10	SH AFC060010B-48	†‡	\$71.63
¾ NPT	½ CTS .090/DR7	84"	10	SH AFC060010B-84	†‡	\$77.24
¾ NPT	¾ IPS DR11	36"	10	SH AFC060060Y-36	‡	\$124.64
¾ NPT	¾ IPS DR11	48"	10	SH AFC060060Y-48	‡	\$134.91
¾ NPT	¾ IPS DR11	84"	10	SH AFC060060Y-84	‡	\$151.78

† = CSA Approved / ‡ = IAPMO/UPC Listed

Recommended accessories: riser brackets, stakes, anodes

RISERS MUST BE ORDERED IN MULTIPLES OF BUNDLE OR BOX QUANTITY LISTED



Gas Connectors & Accessories

CONFLEX RISERS

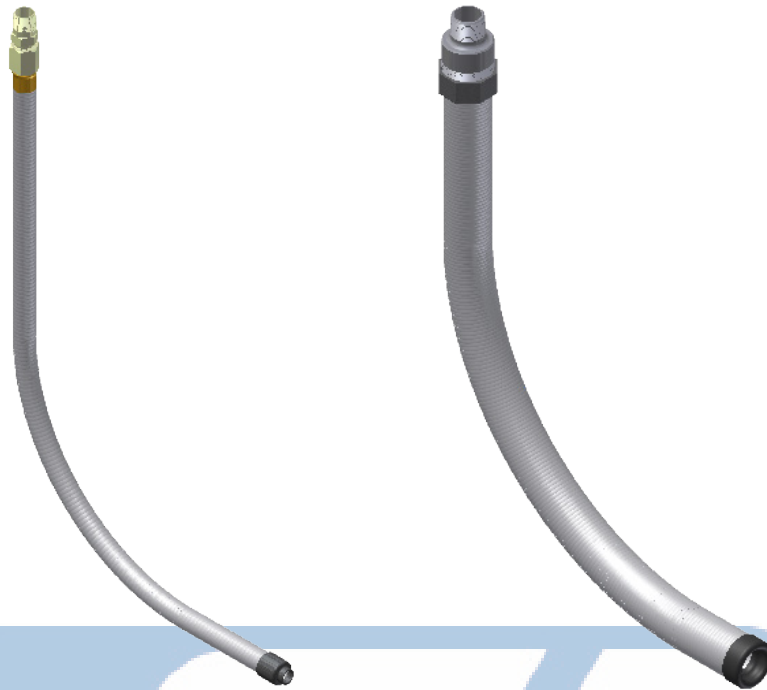

CONTINENTAL INDUSTRIES CONFLEX RISERS				
SIZE (MPT X PE)	WALL	LENGTH	PART NUMBER	LIST PRICE
1/2" MPT X 1/2" CTS (5/8" OD) PE	.090	36"	1253-92-1004-36	\$41.73
		48"	1253-92-1004-48	\$44.73
		60"	1253-92-1004-60	\$47.69
		72"	1253-92-1004-72	\$48.54
		84"	1253-92-1004-84	\$61.86
		96"	1253-92-1004-96	\$59.01
3/4" MPT X 1/2" CTS (5/8" OD) PE	.090	36"	1353-92-1004-36	\$39.18
		48"	1353-92-1004-48	\$42.16
		60"	1353-92-1004-60	\$45.12
		72"	1353-92-1004-72	\$45.80
		84"	1353-92-1004-84	\$56.48
		96"	1353-92-1004-96	\$57.32
3/4" MPT X 3/4" IPS PE	SDR-11 (.095)	36"	1353-92-1013-36	\$67.67
		48"	1353-92-1013-48	\$69.22
		60"	1353-92-1013-60	\$75.14
		72"	1353-92-1013-72	\$91.09
		84"	1353-92-1013-84	\$91.04
		96"	1353-92-1013-96	\$98.84
1" MPT X 1" CTS (1 1/8" OD) PE	.099/.101	36"	1453-92-1008-36	\$90.43
		60"	1453-92-1008-60	\$95.43
		72"	1453-92-1008-72	\$106.73
		84"	1453-92-1008-84	\$113.86
		96"	1453-92-1008-96	\$120.56
1" MPT X 1" IPS PE	SDR-11 (.119)	36"	1453-92-1014-36	\$170.52
		60"	1453-92-1014-60	\$183.48
1 1/4" MPT X 1 1/4" IPS PE	SDR-10 (.116)	36"	1553-96-1015-36	\$190.20
	SDR-11 (.151)	36"	9953-99-0445-00	\$172.46
1 1/2" MPT X 1 1/2" IPS PE	SDR-11 (.173)	36"	1653-96-1016-36	\$259.17
2" MPT X 2" IPS PE	SDR-11 (.216)	36"	1753-96-1017-36	\$262.69

• For sizes not listed, contact Continental Industries.

COMPRESSION (ANODE) RISERS



Gas Connectors & Accessories

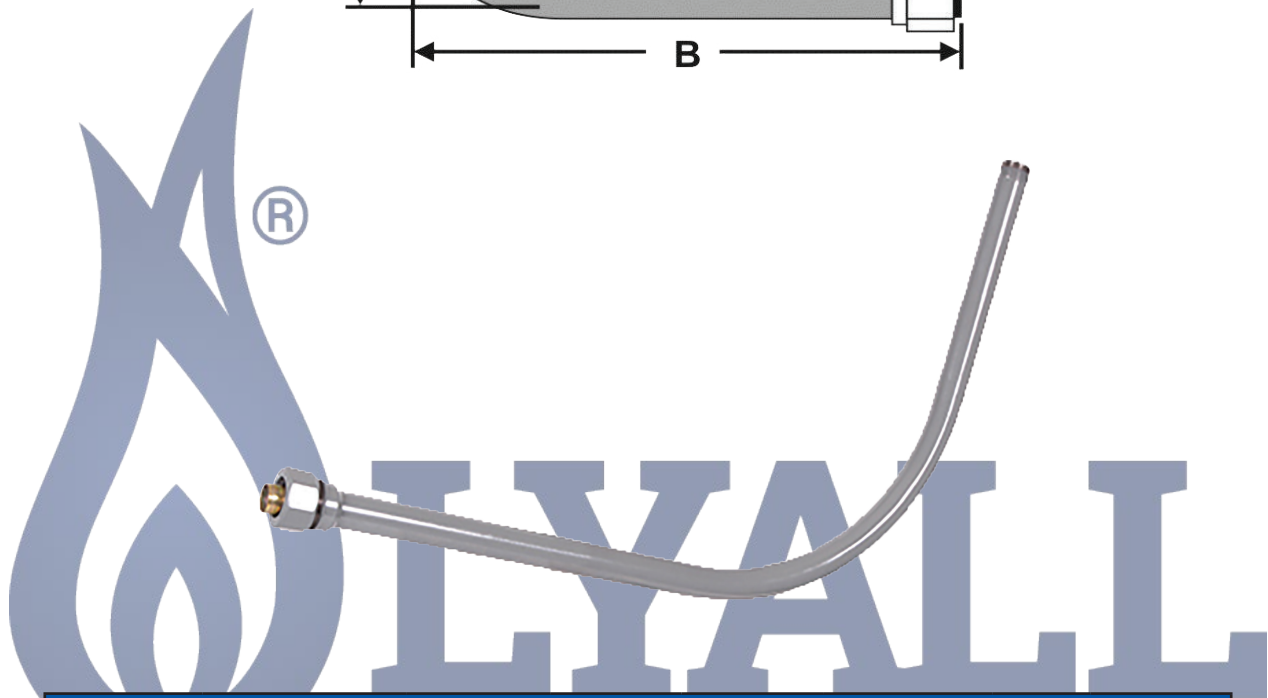
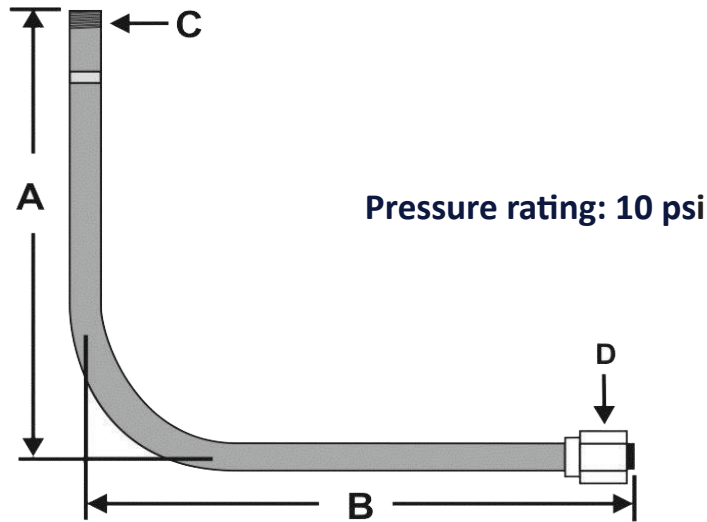

LYALL COMPRESSION (ANODE) RISERS

THREAD END "C"	COMPRESSION END "D"	VERTICAL LENGTH "A"	HORIZONTAL LENGTH "B"	BUNDLE/MIN. ORDER QTY.	PART NUMBER	NOTES	LIST PRICE
3/4 NPT	3/4 IPS DR11	30"	30"	12	221051050830	‡	\$88.15
1 NPT	1 IPS DR11	30"	30"	6	221321320830	‡	\$97.87
1 1/4 NPT	1 1/4 IPS DR10	30"	30"	6	221661660730	‡	\$127.59
1 1/2 NPT	1 1/2 IPS DR11	30"	30"	4	221901900830	‡	\$182.45
2 NPT	2 IPS DR11	30"	30"	2	222382380830	‡	\$241.70

‡ = IAPMO/UPC Listed

Recommended accessories: riser brackets, stakes, anodes

RISERS MUST BE ORDERED IN MULTIPLES OF BUNDLE OR BOX QUANTITY LISTED



Gas Connectors & Accessories

TRANSITION (ANODE) RISERS

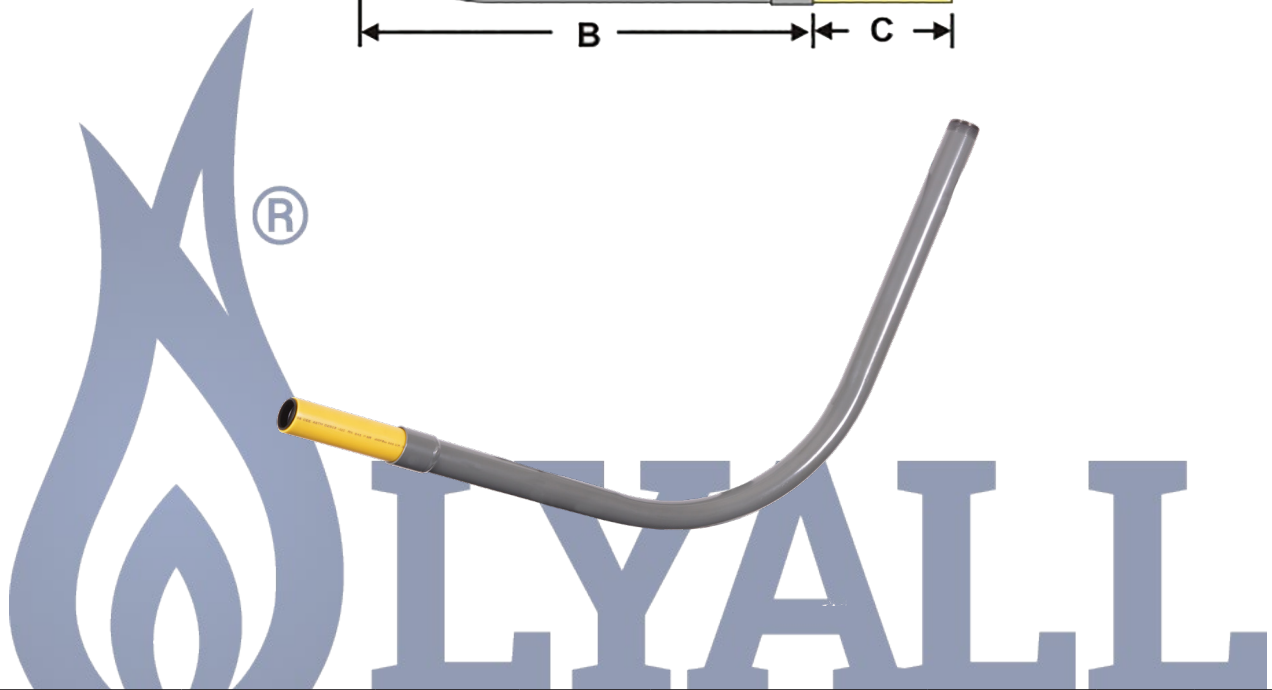
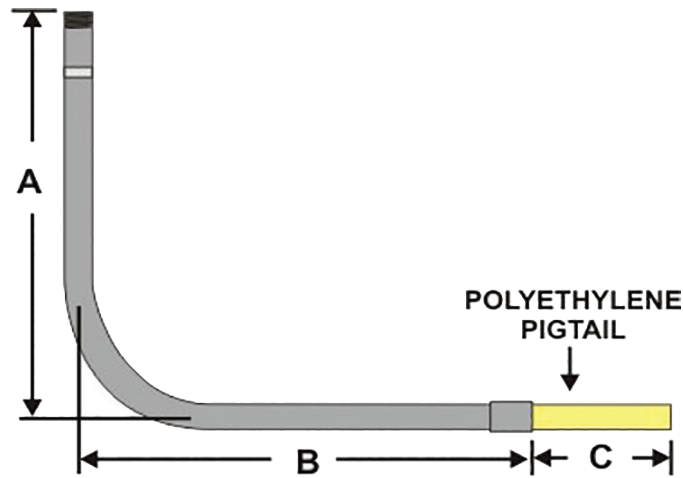

LYALL TRANSITION (ANODE) RISERS

SIZE STEEL X PE	PE TYPE	VERTICAL LENGTH "A"	HORIZONTAL LENGTH "B"	PE LENGTH "C"	BUNDLE/MIN. ORDER QTY.	PART NUMBER	NOTES	LIST PRICE
¾ NPT X ¾ IPS DR11	PE2406/PE2708	30"	30"	6"	9	201051050830	‡	\$64.90
1 NPT X 1 IPS DR11	PE2406/PE2708	30"	30"	6"	6	201321320830	‡	\$86.47
1 ¼ NPT X 1 ¼ IPS DR10	PE2406/PE2708	30"	30"	6"	4	201661660730	‡	\$99.12
1 ½ NPT X 1 ½ IPS DR11	PE2406/PE2708	30"	30"	6"	4	201901900830	‡	\$115.27
2 NPT X 2 IPS DR11	PE2406/PE2708	30"	30"	6"	2	202382380830	‡	\$150.34

‡ = IAPMO/UPC Listed

Recommended accessories: riser brackets, stakes, anodes

RISERS MUST BE ORDERED IN MULTIPLES OF BUNDLE OR BOX QUANTITY LISTED

BRACKETS & SUPPORT STAKES



Gas Connectors & Accessories



Riser Wall Bracket

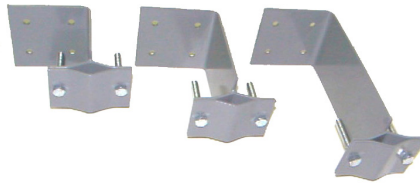

Offset Adjustable Riser Wall Bracket

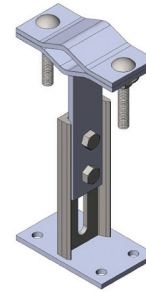

Adjustable Riser Wall Bracket



Riser Support Stake

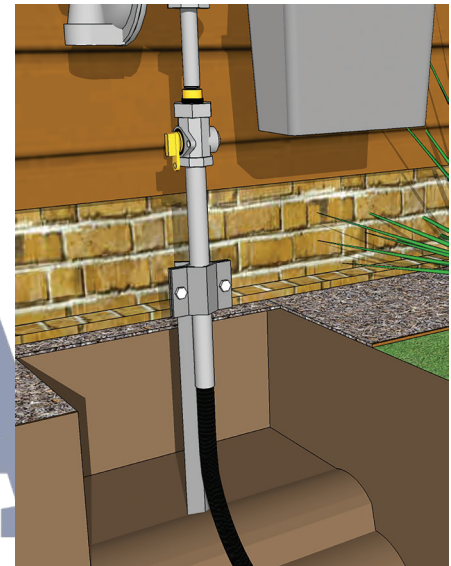
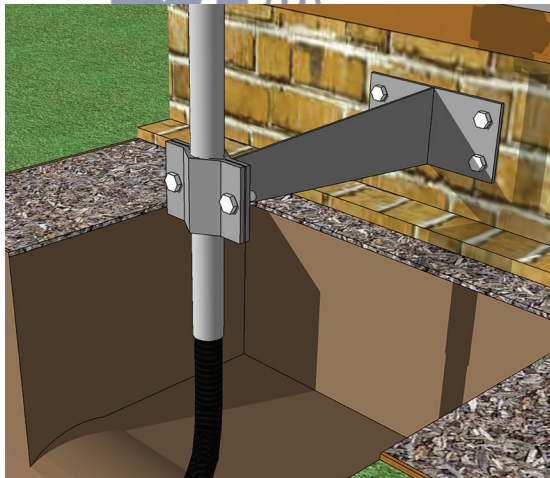

BRACKETS & SUPPORT STAKES

PRODUCT DESCRIPTION	PRODUCT SUPPORT	BUNDLE/MIN. ORDER QTY.	PART NUMBER	LIST PRICE
Wall Bracket - 9"	Riser	10	BRK9H	\$54.93
Offset Adjustable Wall Bracket - 14"	Riser	10	BRK38-01	\$53.58
Support Stake - 48"	Riser	20	BRK32	\$54.13



Gas Connectors & Accessories

RISER BRACKETS

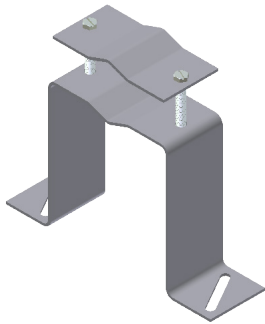

17-6133-00
6" Stand-Off
(List Price \$46.03)

- (2) 3/8" wide x 2" long angular mounting slots
- Accommodates 1/2" thru 1 1/4" flex risers
- Powder coated finish
- Mounting hardware included

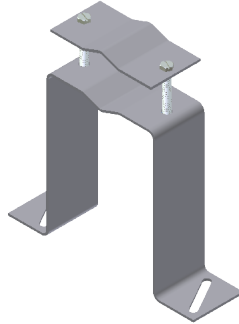

17-6134-00
9" Stand-Off
(List Price \$47.97)

- (2) 3/8" wide x 2" long angular mounting slots
- Accommodates 1/2" thru 1 1/4" flex risers
- Powder coated finish
- Mounting hardware included

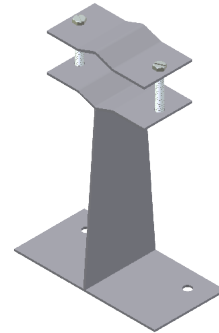

17-6134-01
9" Stand-Off
(List Price \$47.97)

- Accommodates 1/2" thru 1 1/4" flex risers
- Powder coated finish
- Mounting hardware included

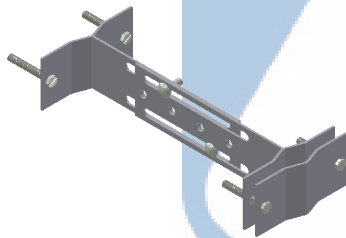

17-6135-00
Universal Riser Bracket
(List Price \$74.58)

- Can be used for virtually any mounting situation
- Foundation, single or double remote installations
- Accommodates 1/2" thru 2" risers
- Carriage bolts supplied for ease of assembly
- Powder coated finish
- Foundation mounting hardware included
- (2) 3/8 wide x 1-5/8 straight mounting slots (Drivepost shown sold separately)

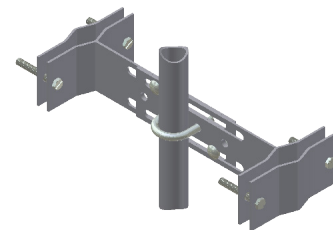
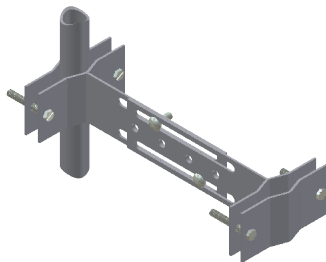
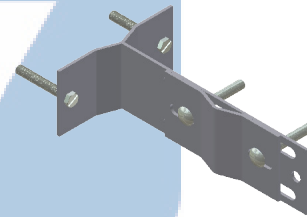

POLYTEC BALL VALVES



Gas Connectors & Accessories

BALL VALVES - MEDIUM DENSITY PE 2406/2708



BALL VALVES - MEDIUM DENSITY PE 2406/2708					
PE Pipe Size	Wall Thickness	Port	BoxQty.	Product Code	List Price
½	.090	Full	5	BV0010B-TFNO-000	\$66.05
1 CTS	.099-.102	Full	5	BV0030D-TFNO-000	\$66.05
1 ¼	.090	Standard	5	BV0040B-TSNO-000	\$66.05
½ IPS	DR9.3	Full	5	BV0050W-TFNO-000	\$69.64
¾ IPS	DR11	Full	5	BV0060Y-TFNO-000	\$69.64
1 IPS	DR11	Full	5	BV0070Y-TFNO-000	\$69.64
1 ¼	DR10	Standard	5	BV0080X-TSNO-000	\$69.64
1 ¼	DR11	Standard	5	BV0080Y-TSNO-000	\$69.64
1 ½	DR11	Standard	5	BV0090Y-TSNO-000	\$69.64
2 IPS	DR11	Standard	1	BV0200Y-TSNO-000	\$90.78
2 IPS	DR11	Full	1	BV0200Y-TFNO-000	\$147.09
3 IPS	DR11	Full	1	BV0300Y-TFNO-000	\$188.80
4 IPS	DR11	Standard	1	BV0400Y-TSNO-000	\$481.06
4 IPS	DR11	Full	1	BV0400Y-TFNO-000	\$542.96
6 IPS	DR11	Standard	1	BV0600Y-TSNO-000	\$597.93
6 IPS	DR11	Full	1	BV0600Y-TFNO-000	\$1,161.01
8 IPS	DR11	Full	1	BV0800Y-TFNO-000	\$1,359.72
10 IPS	DR11	Full	1	BV1000Y-TFNO-000	\$2,481.61
12 IPS	DR11	Standard	1	BV1200Y-TSNO-000	\$7,571.54
12 IPS	DR11	Full	1	BV1200Y-TFNO-000	Call for Pricing
14 IPS	DR11	Full	1	BV1400Y-TFNO-000	Call for Pricing
16 IPS	DR11	Full	1	BV1600Y-TFNO-000	Call for Pricing

BALL VALVES MUST BE ORDERED IN MULTIPLES OF BUNDLE OR BOX QUANTITY LISTED



Gas Connectors & Accessories

POLYTEC BALL VALVES

BALL VALVES - HIGH DENSITY PE 3408/4710

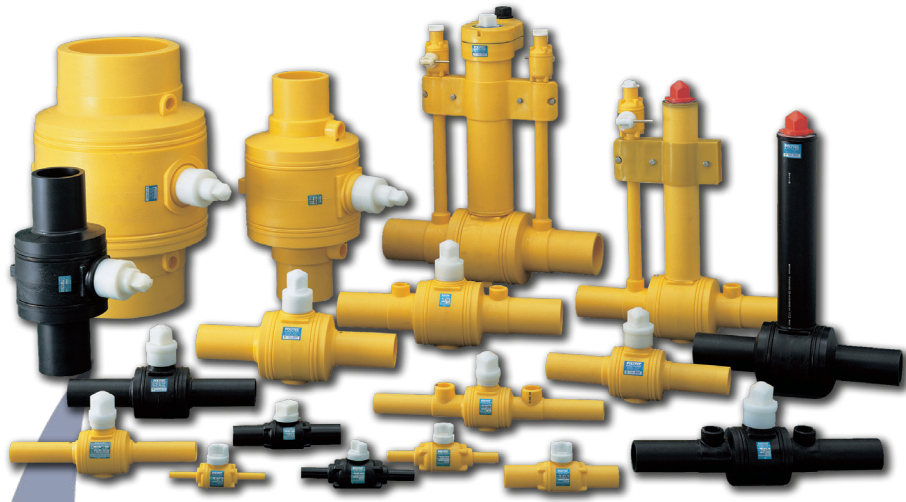

BALL VALVES - HIGH DENSITY PE 3408/4710					
PE Pipe Size	Wall Thickness	Port	Box Qty.	Product Code	List Price
1/2	.090	Full	5	BV0010B-MFNO-000	\$66.05
1 CTS	.099-.102	Full	5	BV0030D-MFNO-000	\$66.05
3/4 IPS	DR11	Full	5	BV0060Y-MFNO-000	\$69.64
1 IPS	DR11	Full	5	BV0070Y-MFNO-000	\$69.64
1 1/4	DR11	Standard	5	BV0080Y-MSNO-000	\$69.64
1 1/2	DR11	Standard	5	BV0090Y-MSNO-000	\$90.78
2 IPS	DR11	Standard	1	BV0200Y-MSNO-000	\$147.09
2 IPS	DR11	Full	1	BV0200Y-MFNO-000	\$188.80
3 IPS	DR11	Full	1	BV0300Y-MFNO-000	\$481.15
4 IPS	DR11	Standard	1	BV0400Y-MSNO-000	\$597.73
4 IPS	DR11	Full	1	BV0400Y-MFNO-000	\$542.96
6 IPS	DR11	Standard	1	BV0600Y-MSNO-000	\$1,161.01
6 IPS	DR11	Full	1	BV0600Y-MFNO-000	\$1,359.72
8 IPS	DR11	Full	1	BV0800Y-MFNO-000	\$2,481.61
10 IPS	DR11	Full	1	BV1000Y-MFNO-000	\$7,571.54
12 IPS	DR11	Standard	1	BV1200Y-MSNO-000	\$10,052.36
12 IPS	DR11	Full	1	BV1200Y-MFNO-000	\$17,665.38
14 IPS	DR11	Full	1	BV1400Y-MFNO-000	CallforPricing
16 IPS	DR11	Full	1	BV1600Y-MFNO-000	CallforPricing

BALL VALVES MUST BE ORDERED IN MULTIPLES OF BUNDLE OR BOX QUANTITY LISTED

TRACER WIRE



Gas Connectors & Accessories



SOLID COPPER
TRACER WIRE



COPPER CLAD STEEL
TRACER WIRE

TRACER WIRE										
CONDUCTOR SIZE	STRANDING	INSULATING MATERIAL	INSULATING THICKNESS NOMINAL	FINISHED O.D. NOMINAL	WEIGHT (PER 1000 FT.)	TEMP. RATING	OPERATING VOLTAGE	INSULATION COLOR	ITEM NO. (500' Reels)	LIST PRICE
10 AWG Copper	Solid	HMWPE	0.030"	0.164"	36.59 lbs.	-20°C to 80°C	30v	Yellow-Gas	33-7778-01	Contact Continental Industries Customer Services for Pricing
12 AWG Copper				0.142"	24.03 lbs.				33-7699-01	
14 AWG Copper				0.126"	16.11 lbs.				33-7692-01	
18 AWG Copper				0.102"	7.67 lbs.				33-7744-01	
10 AWG Copper Clad Steel				0.164"	33.93 lbs.				33-7807-01	
12 AWG Copper Clad Steel				0.142"	22.03 lbs.				33-7701-01	
14 AWG Copper Clad Steel				0.126"	14.85 lbs.				33-7700-01	
18 AWG Copper Clad Steel				0.102"	7.22 lbs.				33-7809-01	

Other insulating colors are available; Red, Blue, and Green.



Gas Connectors & Accessories

SPECIAL ORDER PRODUCTS

The products listed on the previous pages represent the most commonly used sizes and configurations. Additional sizes, custom configurations and options for these products are available as Special Orders. In addition, the following products and services are also available as Special Orders. Contact your Lyall sales representative or customer service for pricing, minimum order quantities and lead times for these products.

LYCOFIT® REDUCER TEES



INSULATED UNIONS

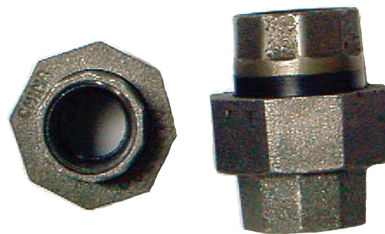

COPO COPPER TO PE FITTINGS



FIELD ASSEMBLED SERVICE RISERS



FACTORY ASSEMBLED RISER OPTIONS



Anodeless Riser with factory assembled valve, LYCOFIT® coupling and support stake options.

OTHER AVAILABLE PRODUCTS



Gas Connectors & Accessories

PVC WATER SADDLES

FASTTAP



- Full wrap around saddle design eliminates stress points being applied to main.
- Tapping process uses simple combination tapping tool eliminating cumbersome tapping machines.
- Tapping cutter retains the coupon then functions as a cut-off valve eliminating corporation stops.
- Manufactured from non-corrosive materials.
 - PVC with PPI HDB Listing
 - 316 Stainless Steel Bolts
 - Brass Cutter
- Available to work with 4"-10" AWWA C-900 and 1 1/4"-12" iron pipe size mains.
- Compression, solvent-weld and threaded outlets for 3/4" to 1" PVC, PE, PB and copper tubing.
- Application may be for wet or dry taps.
- See www.nsf.org for Continental's NSF Listing to Standard 61.
- Reduces time involved with installation by 50%!

FASTTHRED



- PVC saddles for IPS mains.
- Excellent for dry taps and irrigation systems.
- Available in 1 1/4" thru 8" iron pipe size mains.
- Compression, solvent-weld and threaded outlets for 3/4" to 1" PVC, PE, PB and copper tubing.



SUPER FASTTAP



- Full wrap around saddle design eliminates stress points being applied to main.
- Tapping process uses simple combination tapping tool eliminating cumbersome tapping machines.
- Tapping cutter retains the coupon then functions as a cut-off valve eliminating corporation stops
- Manufactured from non-corrosive materials.
 - PVC with PPI HDB Listing
 - 316 Stainless Steel Bolts
- Available to work with 2"-6" iron pipe size mains.
- Compression and solvent-weld outlets to work with 1 1/4" and 2" PVC, PE, PB tubing.
- Application may be for wet or dry taps.
- See www.nsf.org for Continental's NSF Listing to Standard 61.
- Reduces time involved with installation by 50%!



STANDARD CONDITIONS OF SALE

STANDARD CONDITIONS OF SALE

1. **Applicability.** Hubbell Gas Connectors & Accessories hereby offers for sale to the buyer named on the face hereof ("Buyer") the products or services listed on the face hereof (the "Products") on the express condition that Buyer agrees to accept and be bound by the terms and conditions set forth herein. Any provisions contained in any document issued by Buyer are expressly rejected and if these terms and conditions differ from the terms of Buyer's offer, this document shall be construed as a counter offer and shall not be effective as an acceptance of Buyer's document. Buyer's receipt of Products or Seller's commencement of the services provided hereunder will constitute Buyer's acceptance of these terms and conditions. This is the complete and exclusive statement of the contract between Seller and Buyer with respect to Buyer's purchase of the Products. No waiver, consent, modification, amendment or change of the terms contained herein shall be binding unless in writing and signed by Seller and Buyer. Seller's failure to object to terms contained in any subsequent communication from Buyer will not be a waiver or modification of the terms set forth herein. All orders are subject to acceptance in writing by an authorized representative of Seller.
2. **Prices.** Prices in written quotations issued by Seller are valid for thirty (30) days. All other prices are subject to change at any time, unless otherwise expressly agreed by Seller. Any prices shown in published literature are maintained as a general source of information and are not quotations or offers to sell. Seller reserves the right to make corrections due to typographical, clerical or engineering errors or due to incomplete or inaccurate information from Buyer. Prices for accepted orders may change due to customer order, quantity, material or engineering changes.
3. **Taxes.** Prices do not include any state, local, use or excise taxes, duties or other charges now or hereafter imposed for which Seller may be liable as a result of the sale, use or delivery of the Products ("Taxes"). In the absence of proper evidence of exemption supplied by Buyer to Seller, Buyer will be responsible for any and all such Taxes.
4. **Minimum Order Quantity.** Orders are subject to standard package sizes.
5. **Payment Terms.** Subject to credit approval, unless otherwise specified on the quotation or invoice, payment terms shall be Net 30 days from the date of invoice. All payment shall be in US dollars. If Buyer fails to pay any amounts when due, Buyer agrees to pay Seller interest thereon at a periodic rate of the greater of the maximum percentage allowed by law or 1% per month. Buyer will also be responsible for all costs and expenses, including attorneys' fees incurred by Seller in collecting any overdue amounts or otherwise enforcing Seller's rights hereunder.
6. **Shipping and Delivery.** Estimated delivery dates are provided in the quotation or acknowledgment, and shall not represent a fixed or guaranteed ship date. Unless otherwise agreed to by Seller, Seller reserves the right to ship at its convenience and/or ship and invoice for partial orders. All deliveries are FCA Seller's location (INCOTERMS 2010); freight may be pre-paid and added to invoice. Seller may stop delivery of Products in transit and/or withhold shipments in whole or in part if Buyer fails to make any payment to Seller when due or otherwise fails to perform under these terms. In the event of a delay due to any cause beyond Seller's reasonable control, Seller reserves the right to terminate the order or to reschedule the shipment within a reasonable period of time, and Seller shall not be responsible for any damages resulting from delay. If delivery is delayed due to any cause within Buyer's control, Seller may place the Products in storage at Buyer's risk and expense and for Buyer's account.
7. **Title and Risk of Loss.** Title and risk of loss to the Products shall pass to Buyer upon delivery by Seller to the carrier.
8. **Cancellations. Returns.** Orders may not be cancelled or modified once accepted by Seller unless agreed upon in writing by Seller. Any cancellation or return of Products shall be subject to Seller's return policies, and may be subject to Seller's cancellation or restocking fee. Seller's restocking policy is available upon request. Non-stock or special order items are non-cancellable and non-returnable. No returns shall be permitted without a Return Material Authorization (RMA).
9. **Packaging. Allocation.** All Products are packaged in accordance with Seller's standard packaging, unless otherwise agreed upon by the parties. Additional or modified packaging requirements may result in an increase in price. In the event of inability for any reason to supply the total demand for the materials or Products specified, Seller may allocate its available supply among any or all purchasers, at its discretion and without liability for failure of performance that may result therefrom.
10. **Tooling.** Any tooling required for an initial order will be billed to Buyer. Any Non-Recurring Engineering (NRE) charges invoiced by Seller shall not be deemed to grant any right, title or interest in any tools, dies, jigs, fixtures and items of like nature, or in any design, engineering, trade secret, patent or other proprietary rights embodied in the tooling, upon Buyer's payment of such charges and such items shall at all times be, and remain, the property of Seller.
11. **Warranty. Services.** Seller warrants that any services provided hereunder shall be performed in accordance with the standard of care with which such services are normally provided in the industry. If the services fail to meet the applicable industry standards, Seller will re-perform the services, provided that any and all issues are identified prior to Seller demobilizing from the work site. Products. Seller warrants that the Products will perform substantially in accordance with Seller's published specifications (or other applicable specifications as agreed upon in writing by Seller) and will be free from defects in material and workmanship, when subject to normal, proper and intended usage by properly trained personnel. Remedies. Seller agrees to repair or replace Products in order to ensure that the Products perform in accordance with the applicable specifications provided that Buyer shall (a) promptly notify Seller in writing upon the discovery of any defect, which notice shall include the product model and serial number (if applicable) and details of the warranty claim; and (b) after Seller's review, Seller will provide Buyer with a RMA. Buyer may return the defective Products to Seller with all costs prepaid by Buyer. All replaced parts shall become the property of Seller. Shipment to Buyer of repaired or replacement Products shall be made in accordance with the Delivery provisions herein. Any consumables, including but not limited to, bulbs and batteries, are excluded from warranty. Seller will have no obligation to re-perform services, and/or make repairs, replacements or corrections which are defective as a result of: (i) normal wear and tear, (ii) Buyer's misuse, fault or negligence, (iii) use of the Products in a manner for which they were not designed, or (iv) improper storage, maintenance and handling of the Products. If Seller determines that Products for which Buyer has requested warranty services are not covered by the warranty hereunder, Buyer shall pay or reimburse Seller for all costs of investigating and responding to such request at Seller's then prevailing time and materials rates. If Seller provides repair services or replacement parts that are not covered by this warranty, Buyer shall pay Seller therefor at Seller's then prevailing time and materials rates. **INSTALLATION, MAINTENANCE, REPAIR, SERVICE, OR ALTERATION OF THE PRODUCTS PERFORMED BY ANYONE OTHER THAN A SELLER AUTHORIZED PARTY, SHALL IMMEDIATELY VOID AND CANCEL ALL WARRANTIES WITH RESPECT TO THE AFFECTED PRODUCTS. THE OBLIGATIONS CREATED BY THIS WARRANTY TO REPAIR OR REPLACE A DEFECTIVE PRODUCT AND/OR RE-PERFORM SERVICES SHALL BE THE SOLE REMEDY OF BUYER IN THE EVENT OF A DEFECTIVE PRODUCT OR SERVICE. EXCEPT AS EXPRESSLY PROVIDED HEREIN, SELLER DISCLAIMS ALL OTHER WARRANTIES, WHETHER EXPRESS OR IMPLIED, ORAL OR WRITTEN, WITH RESPECT TO THE PRODUCTS, INCLUDING WITHOUT LIMITATION ALL IMPLIED WARRANTIES OF MERCHANTABILITY OR FITNESS FOR ANY PARTICULAR PURPOSE.** In no event will Seller's aggregate liability under warranty exceed the price paid by Buyer for the defective Product or Service. Products supplied by Seller that are obtained by Seller from a third party supplier are not warranted by Seller. At its discretion and to the extent Seller is permitted, Seller agrees to assign to Buyer any warranty rights in such Product that Seller may have from the third party supplier.



STANDARD CONDITIONS OF SALE (Continued)

12. Intellectual Property. Seller's specifications and design of the Products and any developments, improvements and intellectual property created under this order, whether made solely by a party or jointly by Buyer and Seller ("Intellectual Property") shall be owned by Seller. Buyer is not granted any interest, right or license with respect to any such intellectual property, except to the extent required to use the Products for the purpose for which it is specifically provided to Buyer in accordance with these terms and conditions.
13. Software. With respect to any software incorporated in or forming a part of the Products hereunder ("Software"), Seller and Buyer intend and agree that such Software is being licensed and not sold. Notwithstanding anything to the contrary contained herein, Seller or its licensor, as the case may be, retains all rights and interest in Software. Seller hereby grants to Buyer a royalty-free, non-exclusive, nontransferable license, without power to sublicense, to use Software provided hereunder solely in connection with the Products and to use the related documentation solely for Buyer's own internal business purposes. This license will terminate when Buyer's lawful possession of the Products ceases, unless earlier terminated as provided herein. Buyer agrees to not to sell, transfer, license, loan or otherwise make available in any form to Software to any third party. Buyer may not disassemble, decompile or reverse engineer, copy, modify, enhance or otherwise change or supplement the Software without Seller's prior written consent. Seller may terminate this license if Buyer fails to comply with any term or condition herein.
14. Indemnity. By Seller. Seller agrees to indemnify, defend and save Buyer from and against any and all damages, liabilities, actions, causes of action, suits, claims, demands, losses, costs and expenses (including without limitation reasonable attorney's fees) ("Claims") for (i) personal injury or death or damage to real property to the extent caused by the negligence or willful misconduct of Seller, its employees, agents or representatives in connection with the performance of services at Buyer's premises and (ii) claims that a Product infringes any valid United States patent, copyright or trade secret. Notwithstanding the foregoing, Seller shall have no liability the extent any such Claims are caused by either (i) the negligence or willful misconduct of Buyer or third party, (ii) use of a Product in combination with equipment or software not supplied by Seller where the Product would not itself be infringing, (iv) Seller's compliance with Buyer's designs, specifications or instructions, (v) use of the Product in an application or environment for which it was not designed or (vi) service, installation or modification of any Product except by Seller. Buyer shall provide Seller prompt written notice of any Claims and Seller shall have the right to assume exclusive control of the defense of such claim or, at the option of the Seller, to settle the same. Buyer agrees to cooperate reasonably with Seller in connection with the performance by Seller of its obligations in this Section. Notwithstanding the above, Seller's infringement related indemnification obligations shall be extinguished and relieved if Seller, at its discretion and at its own expense (a) procures for Buyer the right, at no additional expense to Buyer, to continue using the Product; (b) replaces or modifies the Product so that it becomes non-infringing, provided the modification or replacement does not adversely affect the specifications of the Product or (c) if neither of the preceding is reasonably practicable, refund the purchase price for the Product. THE FOREGOING INDEMNIFICATION PROVISION STATES SELLER'S ENTIRE LIABILITY TO BUYER FOR THE CLAIMS DESCRIBED HEREIN. By Buyer. Buyer shall indemnify, defend and hold harmless Seller from and against any and all Claims to the extent arising from or in connection with (i) the negligence or willful misconduct of Buyer; (ii) use of a Product in combination with equipment or software not supplied by Seller where the Product itself would not be infringing; (iii) Seller's compliance with designs, specifications or instructions supplied to Seller by Buyer; (iv) use of a Product in an application or environment for which it was not designed; or (v) modifications of a Product by anyone other than Seller.
15. Limitation of Liability. Notwithstanding anything to the contrary contained herein, Seller's aggregate liability for any claim of any kind shall not exceed the price paid by Buyer for the products giving rise to such claim. IN NO EVENT SHALL SELLER BE LIABLE FOR SPECIAL, INCIDENTAL, LIQUIDATED, OR CONSEQUENTIAL DAMAGES HOWSOEVER ARISING OUT OF SELLER'S PERFORMANCE (OR NON- PERFORMANCE) OF THE CONTRACT AND NOTWITHSTANDING WHETHER BUYER MAY HAVE BEEN ADVISED OR IS ADVISED OF THE POSSIBILITY OF SUCH DAMAGES.
16. Compliance with Laws. Export Laws. Seller agrees to observe and comply with all applicable federal, state and local laws, rules, regulations, including but not limited to all applicable laws, regulations, laws, treaties, and agreements relating to the export, re-export, and import of any Product or part of Product. Buyer shall not, without first obtaining any required license to do so from the appropriate U.S. government agency; (i) export or re-export any Product or part of a Product, or (ii) export, re-export, distribute or supply any Product or part of a Product to any restricted or embargoed country or to a person or entity whose privilege to participate in exports has been denied or restricted by the U.S. government. At Seller's request, Buyer will provide information on the end user and end use of any Product or part thereof exported or to be exported by Buyer. Buyer shall cooperate fully with Seller in any audit or inspection related to applicable export or import control laws or regulations, and shall indemnify and hold Seller harmless from, or in connection with, any violation of this section by Buyer or its employees, consultants, or agents.
17. Miscellaneous. (a) Any legal claim shall be controlled under the laws of the state of the Seller's primary place of business. Seller and Buyer agree to accept and be bound by the exclusive jurisdiction of the federal and state courts thereof. The application to this Agreement of the U.N. Convention on Contracts for the International Sale of Goods is hereby expressly excluded. (b) In the event that any one or more provisions contained in these terms shall be held by a court of competent jurisdiction to be invalid, illegal or unenforceable in any respect, the validity, legality and enforceability of the remaining provisions contained herein shall remain in full force and effect. (c) Seller's failure to enforce or waiver of a breach of any provision contained herein shall not constitute a waiver of any other breach or of such provision. (d) Any notice or communication required or permitted hereunder shall be in writing and shall be deemed received when personally delivered or three (3) business days after being sent by certified mail, postage prepaid, to a party at the address specified herein or at such other address as either party may from time to time designate to the other. (e) Buyer may not assign or delegate any rights or obligations without Seller's prior written consent. (f) Seller reserves the right to place a Lien and notifications of liens should Seller not be paid for equipment and or services provided hereunder. (g) Buyer agrees that all pricing, discounts, data, design and technical information, operations/maintenance manuals, testing procedures, drawings, schematics and any other information regarding the Products or Seller's processes provided by Seller to Buyer are the confidential and proprietary information of Seller. Buyer agrees to (a) keep such information confidential and not disclose such information to any third party, and (b) use such information solely for Buyer's internal purposes and in connection with the Products supplied hereunder. Nothing herein shall restrict the use of information available to the general public.



Gas Connectors & Accessories

Hubbell Gas Connectors & Accessories

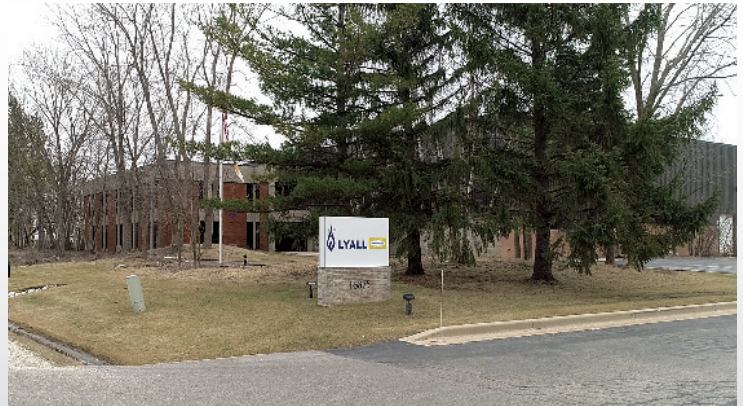

Locations

- Tulsa OK
- Broken Arrow
- OK Corona CA
- New Berlin WI

0000-99-8002-00 11/19



www.hubbell.com